



Enterprise Edge Feature Programming Telephone Guide

Contents

Chapter 1	Getting Started	11
	Using this guide	11
	Before you start	11
	What you'll need to do programming	11
	Understanding the telephone buttons	12
	Using the buttons under the display	12
	The M7410 Cordless Telephone (CT)	14
Chapter 2	Answering calls	15
	Answering incoming calls with Hunt Groups	15
	Answering an incoming call	15
	Line buttons	15
	What line indicators mean	16
	Rings you may hear	16
	Answering calls at a prime telephone	16
	Using a central answering position (CAP) module	17
	Customizing your CAP module	17
	Monitoring telephones with the CAP module	17
	Release button	18
	Hearing aid compatibility	18
	Viewing information about a call on the display	18
	Using Call Information for a particular call	18
	Displaying Call Information before or after answering	19
	Displaying Call Information for a call on hold	19
	Making Call Display information appear automatically at a telephone	19
	Changing which information is shown first about a call	20
	Picking up a call ringing at another telephone	20
	Answering any ringing telephone using Directed Pickup	20
	Answering any ringing telephone using Group Pickup	20
	Changing a telephone's pickup group	21
	Trunk Answer	21
	Answering a call using Trunk Answer	22
	Answer buttons	22
	Creating a Conference Call	23
	Disconnecting one party	23
	Independently holding two calls	24
	Putting a conference on hold	24
	Removing yourself from a conference	25
	Listening to a call as a group	26

- Canceling Group Listening 26
- Using Handsfree/Mute 26
 - Answering calls without lifting the receiver 26
 - Making calls without lifting the receiver 27
 - Muting Handsfree 27
 - Changing a regular call to handsfree 27
 - Changing a handsfree to a regular call 27
 - Using Handsfree 27
 - Changing Handsfree for a telephone 28
 - Handsfree Answerback 28
- Turning Privacy on or off for a call 29
 - Creating a conference by releasing privacy 29
 - Making a call private 29
- Checking call length using Call Duration Timer 29
- Disconnecting by accident 30
- Time 30

Chapter 3 Making calls 31

- Choosing a line using a line button 32
- Line pools 32
 - Using a line pool to make a call 33
 - Programming a memory button with a line pool feature code 33
- Changing how you dial your calls 34
 - Using Standard dial 34
 - Using Automatic dial 34
 - Using Pre-dial 34
- When the internal number you have called is busy 35
 - Priority Call 35
 - Making a priority call 35
 - Giving a telephone the ability to make priority calls 35
 - Using Ring Again 36
 - Turning on Ring Again 36
 - Canceling Ring Again 36

Chapter 4 Time savers for making calls 37

- Storing a number on a memory button for Autodial 37
 - Adding an autodial button 37
 - Choosing a line for Autodial 37
 - Using intercom as the line for Autodial 38
- Using Last Number Redial 39
- Preventing a telephone from using Last Number Redial 39
- Using Speed Dial 39
- Making a speed dial call 40
 - Changing and adding System Speed Dials 40

	Adding or changing User Speed Dial	40
	Using Saved Number Redial	41
	Saving a number	41
	Dialing a saved number	42
	Preventing a telephone from using Saved Number Redial	42
Chapter 5	Handling many calls at once	43
	Using Hold	43
	Retrieving a held call	43
	Holding automatically	43
	Listening on hold	43
	Holding a call exclusively	44
	Using Call Queuing	44
Chapter 6	Transferring calls	45
	Using the transfer feature	45
	Transferring a call	45
	Transferring external calls	45
	Canceling a transfer	46
	Using Camp-on	47
	Parking a call	48
	Retrieving a parked call	48
	Using Call Park	48
	Using Callback	50
Chapter 7	Forwarding your calls	51
	Forwarding your calls to another telephone	51
	Canceling Call Forward	51
	Using Call Forward at your telephone	51
	Overriding Call Forward	52
	Changing the automatic Call Forward settings for a telephone	52
	Changing Forward no answer	52
	Changing the delay before a call is forwarded	52
	Forward on busy	52
	DND on Busy	53
	Call Forward and voice mail	53
	Line Redirection	54
	Turning on Line Redirection	54
	Canceling Line Redirection	55
	Allowing a telephone to redirect calls	55
	Turning the redirect ring for a telephone on or off	55
	How Line Redirection is different from Call Forward	57
	Using Line Redirection	57

Chapter 8 Communicating in the office 59

- Paging 59
 - Making a page announcement 59
 - Activating and deactivating the ability to page 59
 - Creating page zones 60
 - Using Page with external paging equipment 61
- Sending messages 61
 - Sending a message 61
 - Canceling a message you have sent 62
- Viewing your messages 62
 - Replying to a message 62
 - Replying to a message using an analog telephone connected to an ASM 63
 - Removing items from your message list 63
 - Removing items from your message list using an analog telephone connected to an ASM 64
 - Viewing messages you have sent 64
- Using Voice Call 65
 - Making a Voice Call 65
 - Muting Voice Call tones 65
 - Answering a Voice Call without touching your telephone 65
 - Preventing Voice Calls to your telephone using Voice Call Deny 66
 - Canceling Voice Call Deny 66

Chapter 9 Tracking your incoming calls 67

- Using Call Log 67
 - Call Log options 68
 - Logging a call manually 68
 - Deleting old log items 68
 - Viewing your Call Log 68
 - Viewing a Call Log item 69
 - Erasing log items 69
 - Making a call using Call Log 69
 - Creating a password to your Call Log 70
 - Changing your Call Log password 70
 - Deleting an assigned password 70
 - Programming a telephone to log calls automatically 71
- Using voice mail 72

Chapter 10 Customizing your telephone 73

- Finding out what a button does using Button Inquiry 73
- Making the display darker or lighter using Contrast adjustment 73
- Changing the language on the display 74
 - English 74
 - French 74

	Spanish	74
	Programming a feature code onto a memory button	74
	Programming feature buttons	74
	Erasing a feature button	75
	Applying button cap labels	76
	Types of button caps	76
	Identifying the telephones	76
	Enterprise Edge default button assignments	77
	Rules of default button assignment	77
	M7310 telephone button defaults	78
	M7324 telephone button defaults	79
	M7100 telephone button defaults	79
	Moving line buttons	79
	Changing the type of ring	80
	Adjusting the Ring volume	80
	Hiding the message or calls indication	81
	Restoring the messages and calls indication	81
Chapter 11	Hunt Groups	83
	Members of the group	84
	Distribution mode	84
Chapter 12	Telephone features	85
	Installing Enterprise Edge telephones	85
	Naming a telephone or a line	86
	Moving telephones	87
	Stopping calls from ringing at your telephone using Do Not Disturb (DND)	87
	Stopping calls	87
	Refusing to answer a call	87
	Canceling Do Not Disturb	87
	Using Do Not Disturb	88
	Using Background Music	88
	Turning Background Music off	88
Chapter 13	ISDN PRI	89
	Benefits	89
	ISDN PRI features	89
	Network Name Display for PRI	89
	Name and number blocking for PRI	90
	Emergency 911 Dialing	90
	2-way DID	90
	Call by Call service selection for PRI	91

- Dialing Plan and PRI 91
- Service provider features 92
 - Call Forward 92
 - Canceling Call Forward 92
 - Calling the number your calls are forwarded to 92
 - Automatic Call Back 92
 - Automatic Recall 93
- ISDN applications for PRI 93
 - Videoconferencing and video telephony 93
 - Desktop conferencing 93
 - File transfer 93
 - Telecommuting 93
 - Group 4 fax 93
 - Remote LAN access 93
 - Leased line backup 93
 - LAN to LAN bridging 94
 - Internet and database access 94

Chapter 14 Using System features 95

- Using alternate or scheduled services 95
 - Preventing certain calls from being made 95
 - Making additional telephones ring 95
 - Changing the lines used by outgoing calls 95
- Turning Services on and off 95
- Turning Services on and off using feature codes 96
 - Viewing the active Services from a two-line display telephone 96
 - Viewing the active Services from a one-line display telephone 97
- User passwords 98
 - Registration password 98
 - Clearing a Call Log password 98
- Using special telephones 98
 - Direct-dial 98
 - Changing the direct-dial telephone assignments 99
 - Hotline 99
 - Bypassing a Hotline 99
 - Making a telephone a hotline telephone 99
 - Control telephone 100
- Using Set lock 100
- Changing Set Lock programming for a telephone 100
- Using an auxiliary ringer 101
 - Turning the auxiliary ringer for a telephone on or off 101
- Using Host System dialing signals 101
 - Link 101
 - Preventing a telephone from using Link 101
 - Pause 102

	Long Tones	102
	Programmed Release	102
	Run/Stop	103
	Wait for Dial Tone	103
	Using pulse dialing for a call	103
	Using your Enterprise Edge system from an external location	103
	Controlling access to your Enterprise Edge system	104
	Direct inward system access (DISA)	104
	Class of Service (COS)	104
	Maintaining security	105
	Accessing Enterprise Edge remotely over the public network	105
	Tones	105
	Using Class of Service (COS) passwords	106
	Changing your Class of Service	106
Chapter 15	General System features	107
	Pulse or tone dialing	107
	Disconnect supervision	107
	Hunt Groups	107
	Internal numbers	107
	Line assignment	107
	Target line	108
	Line pools	108
	Overflow call routing	108
	M7100 telephone	109
	Memory buttons	109
	One-line display	109
	Prime line	110
	Private lines	110
	Volume bar	110
	Wall mounting	110
Chapter 16	Hospitality Services	111
	Alarm time (AL) feature	111
	Hospitality Services admin alarm feature	113
	Room occupancy (RO)	114
	Room condition (RC)	114
	Hospitality programming	116
Chapter 17	Companion Features	117
	Using your portable telephone	117
	Using Enterprise Edge features	118
	Using new features	119
	Supporting additional features for portables	120

Chapter 18 Troubleshooting 121

Using the alarm telephone 121

Reporting and recording alarm codes 121

Testing the telephone 121

Testing the telephone display 122

Testing the telephone buttons 122

Testing the speaker in the telephone handset 122

Testing the telephone headset 123

Testing the telephone speaker 123

Testing the power supply to a telephone 123

Chapter 19 Common feature displays 125

Chapter 20 Appendix A: Feature Codes 129

Chapter 21 Index 135

Your Enterprise Edge telephone system has many powerful features that can be customized to keep up with changes in your workplace.

Using this guide

This guide provides information on personal programming, which is done from the user's telephone set, such as personal speed dials, transferring a call, and so on.

Before you start

Before you begin programming, plan what changes you want to make. Record the changes so that you have the information at hand. For example, if you are going to program system speed dial numbers, create a record so that you have all the numbers and codes handy once you start programming.

What you'll need to do programming

Personal programming is done right on your telephone by pressing the button followed by an activation code. For your convenience, a summary of all the Feature button programming is provided in Appendix A.

System programming is done using the Unified Manager. The Unified Manager is the tool used to program settings for the Enterprise Edge telephony features, as well as settings for individual telephones and external lines. Multiple levels of programming are accessible through the Unified Manager. You access the **Enterprise Edge Unified Manager** from your web browser. For more information about navigation and making selections using the Unified Manager, see the *Enterprise Edge Programming Operations Guide*.

Emergency 911 Dialing

Emergency 911 Dialing is the capability to access a public emergency response system by dialing the digits "9-1-1"



Emergency 911 Dialing

State and local requirements for support of Emergency 911 Dialing service by Customer Premises Equipment vary. Consult your local telecommunications service provider regarding compliance with applicable laws and regulations.

Understanding the telephone buttons

Take a few minutes to study the telephone buttons. The M7324 is different from the M7310 and M7208 in two ways: it does not have dual memory buttons or a shift button.

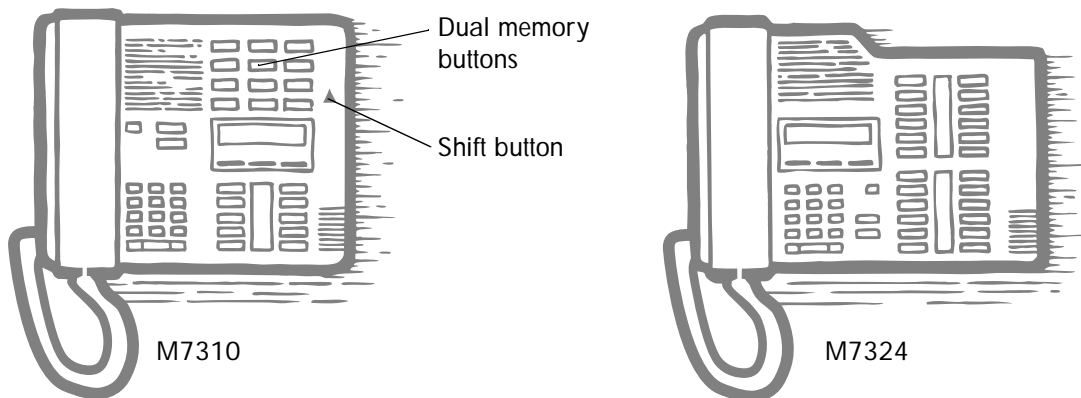

Using the buttons under the display

The three display buttons are used for telephone features but what each button does depends on what the display shows. Some display instructions that you may see when making changes on the system are OK, CHANGE or COPY. In this guide, display button instructions are underlined.

Display buttons



M7310

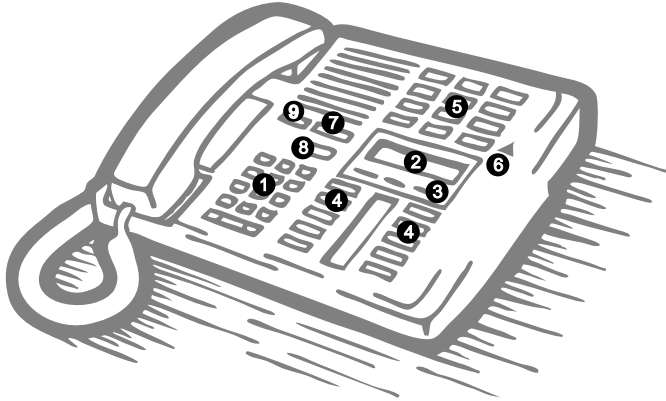

① Dial pad	Used for dialing numbers when you are making calls. It's also used for entering numbers and letters when you're programming.
② Display	Shows instructions for everyday calling as well as for programming.
③ Display buttons	Have a variety of uses. The current use is shown on the display above each button.
④ Memory buttons	Dial a number or feature code stored on the button.
⑤ Dual memory buttons	Can store two numbers or feature codes (used with the shift button).
⑥ Shift button	Press the shift button before a dual memory button to activate the second number or feature code stored on a dual memory button.
⑦ Feature button	Allows you to enter a feature code while using or programming the telephone.
⑧ Hold button	Puts an active call on hold.
⑨ Release button	Hangs up an active call or ends programming.

The M7410 Cordless Telephone (CT)

The M7410 CT allows you to move freely around your workspace and still have full access to all your Enterprise Edge system features.

The effective operating radio range in your facility will be dependent upon building construction and the internal layout of the facility. Typically, a dense office environment will yield an effective operating radio range of 125 to 150 feet. Operating radio ranges will be enhanced in more open office environments.

Note: Note: Up to 15 M7410 CT users can be accommodated on one Enterprise Edge system.

The M7410 CT uses advanced digital technology to provide a quality audio path over a 900 MHz radio link. Establishing calls over a radio link are comparable to wire line communications but expect small delays when the handset is brought into service from an on-hook position.

The M7410 CT mixes voice and data communications paths together, making it very difficult for anyone to tune in and eavesdrop on conversations. The M7410 CT is equipped with automatic channel scanning capabilities. The M7410 CT automatically searches for a new channel when interference is detected.

Answering incoming calls with Hunt Groups

Your Enterprise Edge system allows you to establish Hunt Groups in your system. Hunt Groups are a group of Enterprise Edge set DNs that can be called by a single directory number. The Hunt Groups feature ensures calls are easily routed to the appropriate people. You can program

- the members for a Hunt Group
- member position within a Hunt Group
- how calls are distributed
- how long a call spends looking for available members
- what happens if all members are busy

For more information on Hunt Groups see the *Enterprise Edge Programming Operations Guide*.

Answering an incoming call

There are three indications of an incoming call: ringing, a line button flashing, and a message on the display. You do not necessarily receive all three indications for any particular call. For example, you may have a line that has been set up not to ring at your telephone. If so, you see only a flashing line button. There are many possible combinations, depending on how your system is set up. See [Choosing a line using a line button](#) on page 32 for more information on the use of lines.

If you receive a priority call and your telephone has no free internal line buttons, you cannot transfer the priority call, you must accept or release it.

Line buttons

One line button for each line is assigned to your telephone. Press the line button to select the line you want to answer or use to make a call. Having several line buttons gives you immediate access to more than one line.

The M7100 telephone has two intercom paths which are used instead of line buttons to answer and make calls. Each M7100 can be assigned two lines. You can press to switch between two calls, one active and one on hold.

What line indicators mean

▶ Flashing on and off for equal lengths of time	There is an incoming call on the line.
▶ Flashing on and off more quickly	You have placed a call on hold.
▶ Flashing on for longer than off	Someone else has put a call on hold on that line.
▶ On, not flashing	You are connected to the call on that line or the line is in use elsewhere.
Off	The line is free.

Rings you may hear

A double beep every ten seconds	A call has been camped to your telephone.
A long single ring	There is an external call on the line for you.
A shorter double ring	There is an internal call on the line for you or a call is being transferred to you.
A brief single ring	A call is being redirected on one of your redirected lines. You cannot answer this call.
Three beeps descending in tone	You are receiving a priority call.

Answering calls at a prime telephone

Each line in an Enterprise Edge system can be assigned a prime telephone. Calls not answered at their normal destinations are transferred to the prime telephone. The prime telephone is usually the attendant's telephone. The installer or customer service representative programs a prime telephone for a line.

Displays

DND from 221	The person at telephone 221 has forwarded a call to you using Do Not Disturb.
DND transfer	The system has transferred a call to you from a telephone with Do Not Disturb turned on.
DRT Line001	Nobody answered this call so the system transferred it to you.
Line061 callback CALLBACK	Someone has camped, parked or transferred a call on line 061, but no one has answered it. Press CALLBACK or the line button to connect to the call.
Line061 to Prime	There is no telephone that can receive a call on line 061 so the system has transferred it to you.
Line002\Line052	The call coming in on line 002 was intended for target line 052. Line 052 is busy so the call has come to you.

For other displays, see [Common feature displays](#) on page 125.

Using a central answering position (CAP) module

A central answering position (CAP) is an Enterprise Edge M7324 telephone and a CAP module that your installer or customer service representative programmed as a CAP. You can have five CAPs connected to an Enterprise Edge telephone. It is best if the CAP is the prime telephone and direct-dial telephone for the lines and telephones it serves.

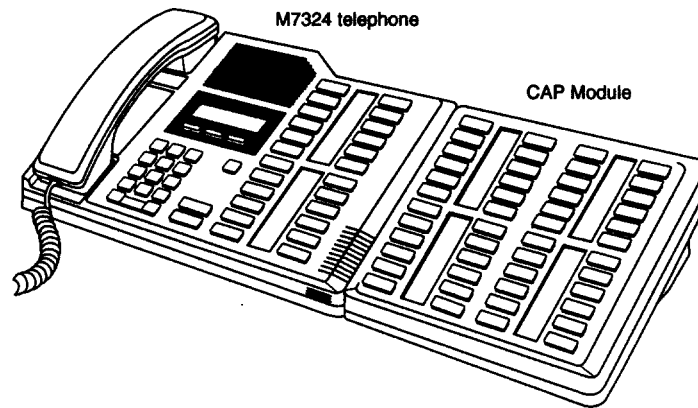

A CAP module is an add-on device that provides 48 extra memory or line buttons. You can connect one or two Enterprise Edge CAP modules to the telephone to increase the number of lines it can handle.

When a CAP module is first plugged into your telephone, some of the module buttons are already programmed to dial an internal number.

Customizing your CAP module

If your installer has programmed the CAP module to be the central answering position for your system, you can move external lines onto the CAP module by using `Feature [] * [8] [1]`. See [Moving line buttons](#) on page 79.

Any of the buttons on your CAP module that do not select lines can be programmed to dial internal or external numbers automatically. You can program features onto CAP module buttons. See [Time savers for making calls](#) on page 37 and [Customizing your telephone](#) on page 73 for information on programming memory buttons.

Buttons on a CAP module cannot be assigned as answer buttons.

Monitoring telephones with the CAP module

The indicators  beside internal autodial buttons on your CAP module show the status of Enterprise Edge telephones.

The indicator is on when the telephone has:

- an active call
- Do Not Disturb turned on

The indicator is off when a telephone has:

- no active call
- a call on hold and no other active call



Tip

You can send up to 30 messages from a CAP.

Release button

Pressing **[Rls]** ends a call. You do not have to put the receiver down. **[Rls]** also ends feature programming.

While you are on a call, do not press **[Rls]** to end a feature you are using. If you do, you disconnect the call. Use **[Feature]** instead.

Hearing aid compatibility

The receivers on all Enterprise Edge telephones are compatible with hearing aids as defined in the FCC rules, Part 68, section 68.316. Not all hearing aids are optimized for use with a telephone.

Viewing information about a call on the display

If you subscribe to Call Display services from your local telephone company, one line of information about an external caller is displayed after you answer.

Depending on the setting and the external information available, either the caller's name or telephone number is displayed.

When you transfer an external call to another Enterprise Edge user, this information is displayed on the recipient's telephone.

Call Display information becomes available between the first and second ring of an incoming call. If you answer before the Call Display information is available on your display, and you press **[Feature]** **[8]** **[1]** **[1]**, you see only the line number or line name.

To use logging features with Call Display, see [Using Call Log](#) on page 67.

Using Call Information for a particular call

[Feature] **[8]** **[1]** **[1]**

Call Information allows you to see information about incoming calls. This information is more detailed than the Call Display information you can receive automatically. For external calls, you can display the caller's name, telephone number, and the line name. For an internal call, you can display the caller's name and their internal number. You can see information for ringing, answered, or held calls.

Call Information is available for calls even if they have been transferred, forwarded or rerouted in some way.

Names and numbers for external calls are displayed only if you have subscribed to Call Display services from your telephone company.



Tip

Call Log displays the same information as Call Information, along with the date and time of the call, and the number of times the caller called.

Displaying Call Information before or after answering

To find out who is calling or to display information about your current call:

1. Press 8 1 1.
2. Press # or VIEW to display more information about an external call.

Call Display information becomes available between the first and second ring of an incoming call. If you answer before the Call Display information is available on your display, and you press 8 1 1, you see only the line number or line name.

Displaying Call Information for a call on hold

1. Press 8 1 1. The display reads **Select a call**.
2. Select the line on hold. Information about the call is displayed.
3. Press # or VIEW to display more information about an external call.



Tip

If your telephone automatically displays Call Display information for a call, you still need to press 8 1 1 before you can press # or VIEW to display more information about the call.

Making Call Display information appear automatically at a telephone

Each telephone that rings for an external line can display Call Display information for that line. After the call is answered, Call Display information is always shown at the telephone that answered the call. Your installer or customer service representative can program telephones to have automatic Call Display.

Changing which information is shown first about a call

Depending on the services you subscribe to, Call Display information may contain up to three parts: the name of the caller, the number of the caller, and the name of the line in your Enterprise Edge system that the call is on. For each telephone, you can determine which information is displayed first.

You may see `Unknown name` or `Unknown number` on the display if the information is not available from your telephone company. You may see `Private name` or `Private number` on the display if the caller blocks that information.

You need to start a Unified Manager session to program this feature. For more information about programming using the Unified Manager, see the *Enterprise Edge Programming Operations Guide*.

Picking up a call ringing at another telephone

You can pick up a call ringing at another telephone by using Directed Pickup or Group Pickup.

Answering any ringing telephone using Directed Pickup

Feature 7 6

You can answer any telephone that is ringing in your Enterprise Edge system.

1. Press 7 6.
2. Enter the internal number of the ringing telephone.
Call Pickup cannot be used to answer private lines.

To use Call Pickup (Directed Pickup), the telephone must be ringing. If, for example, the auxiliary ringer is ringing, but the call is not ringing at a telephone, the call cannot be answered using Directed Pickup. It must be answered normally at a telephone that has a flashing indicator for the call, or by using Trunk Answer. You can answer a call that is ringing because someone has transferred the call to a telephone and the call is ringing on an intercom button.



Tip

Directed pickup can retrieve calls that are ringing on an Answer DN. While you may enter the internal number of the telephone you hear ringing, it may be calls from another telephone you are answering.

Answering any ringing telephone using Group Pickup

Feature 7 5

Your Enterprise Edge system can be divided into nine pickup groups. If you are a member of a pickup group, you can pick up a call that is ringing at any telephone in your pickup group.

Press .

Group Pickup cannot be used to retrieve a camped call.

If there is more than one incoming call at a telephone in a pickup group, a call ringing on an external line is answered first followed by calls on the prime line and, finally, calls on internal lines.



Tip

A Hunt Group call ringing at an Enterprise Edge set DN that is also a member of a call pickup group can be picked up by any Enterprise Edge set in that call pickup group. For more information on Hunt Groups see [Hunt Groups](#) on page 83.

Changing a telephone's pickup group

Telephones can be put into and taken out of pickup groups.

You need to start a Unified Manager session to program this feature. For more information about programming using the Unified Manager, see the *Enterprise Edge Programming Operations Guide*.

Displays

Already joined	You are already connected to the telephone that made the call you are trying to pick up. This can happen if you are on a call to a co-worker, your co-worker dials the number of a telephone in your pickup group, and you attempt to pick up that call.
Pickup denied	There is no call that you can pick up or the call that was ringing has already been answered. You have tried to pick up a call on someone else's private line.
Pickup:	Enter the internal number of the telephone that is ringing. (You may use an internal autodial button to do this.) If you decide not to answer a ringing call after you have activated Directed Pickup, press <input type="text" value="Feature"/> .

Trunk Answer

The Trunk Answer feature allows you to answer a ringing call anywhere in the system from any telephone in the system. The line you are answering does not have to appear or ring at the telephone you are using.

Trunk Answer works only with calls that are ringing on lines for which a Ringing Service schedule is active and if Trunk Answer is enabled by your installer or customer service representative.

Answering a call using Trunk Answer

Press 8 0 0 .



Tip

If there is more than one incoming call on lines in a Ringing Service, the Trunk Answer feature picks up the external call that has been ringing the longest.

Displays

Line denied You have tried to pick up a call on someone else's private line.

Pickup denied The call that is ringing is on a line that is not in a Ringing Service.

Answer buttons

You can use an Answer button to monitor calls on another person's telephone. All calls to the monitored Enterprise Edge telephone appear on the Answer button.

Answer buttons are useful for attendants who monitor incoming calls for one or several other people. For example, a secretary may have appearances for three different bosses on her answer buttons. Once a call for boss A is answered by the secretary, the appearance stops at that boss' set. This allows for another (simultaneous) call to come in on the same line. The same is true for boss B and boss C. When incoming call traffic becomes high, the calls can then be routed to a Hunt Group to optimize call handling. For more information on Hunt Groups see [Hunt Groups](#) on page 83.

The Answer button setting in Feature settings programming allows you to determine what types of calls alert at the telephone. Your choices are: Basic, Enhanced and Extended.

See the *Enterprise Edge Programming Operations Guide* for more information on programming Answer buttons.

M7100 telephones cannot be assigned Answer buttons to monitor other sets, but they can be monitored.

You cannot make calls using Answer buttons.

If more than one call is ringing at someone's telephone, the first call appears on the attendant's Answer button. Any subsequent calls appear on intercom buttons, if they are available.



Tip

More than one attendant may have an Answer button for a single telephone. This allows two or more attendants to handle calls for a busy person.

Each telephone can handle calls for up to eight other people using a separate Answer button for each person.

Creating a Conference Call

Feature 3

You can talk to two people at once.

1. Make sure you have two calls, one active and one on hold.
2. Press 3.
3. Press the appropriate button to retrieve the held call (this is automatic on the M7100 telephone).

You can create a conference when you are on a call.

1. Make a second call.
2. Press 3.
3. Press the button where the first call is on hold to create a conference.

Only the person who established the conference can process the conference by using the procedures described in this section.



Tip

You can create a conference by releasing privacy on a call. See [Turning Privacy on or off for a call](#) on page 29.

Disconnecting one party

You can disconnect one party from a conference and continue talking to the other.

On a M7208, M7310 or M7324 telephone:

1. Press the line button of the call that you want to disconnect. The call that you want to keep is automatically put on hold.

2. Press **[Rls]**. The call is disconnected.
3. Press the line button of the held call to speak to the remaining person.

On a M7100 telephone:

1. Press **[Feature]** **#** **3**, to place one caller on hold. Press **[Hold]** again, to put the caller you want to keep on hold.
2. Press **[Rls]**. The call is disconnected.
3. Press **[Hold]** to speak to the remaining party.

Independently holding two calls

For all Enterprise Edge telephones except the M7100 telephone, you can put the two people in a conference call on hold independently so that they cannot talk to each other.

1. Press the line button of one person. The other person is automatically put on hold.
2. Press **[Hold]**. The second person is put on hold.

You can re-establish the conference.

3. Take one call off hold.
4. Press **[Feature]** **3**.
5. Take the other call off hold.

Putting a conference on hold

You can put a conference on hold, allowing the other two people to continue speaking to each other by pressing **[Hold]**.

You can reconnect to the conference by pressing either of the held line buttons. For the M7100 telephone, press **[Hold]**.

Splitting a conference

You can talk with one person while the other person is on hold.

On a M7208, M7310 or M7324 telephone

- Press the line button of the person to whom you want to speak. The other person is automatically put on hold.

On a M7100 telephone:

1. Press # . The first party is on hold.
2. Press , if necessary, to switch parties.

You can re-establish the conference.

3. Press .
4. Take the held call off hold. This is not necessary for the M7100 telephone.

Removing yourself from a conference

You can remove yourself from a conference, and connect the other two callers through your Enterprise Edge system.

Enter the Transfer feature code .

When you remove yourself from a conference using the Transfer feature, and both callers are from outside your system, one of the callers must have called you on a disconnect supervised line, or the call is be disconnected.

Displays

3 Parties only	You are trying to add a fourth party to your conference call, or to join two conferences together. Release one call from the conference before adding another, or keep the two conferences separate.
Conf. on hold	You have put a conference call on hold.
Conference busy	You have tried to make a conference call, but your system is already handling its maximum number of conference calls.
Line001 221 TRANSFER	You are on a conference with the two lines or telephones shown. You can drop out of the conference and leave the other two parties connected (Unsupervised Conference) by pressing TRANSFER or entering the Transfer feature code.
Press held line	You have activated the Conference feature with one call active and another on hold. Press the line of the call on hold to bring that person into the conference.

For other displays, see [Common feature displays](#) on page 125.

Listening to a call as a group

Feature

To allow people in your office to listen in on a call using Group Listening, press

Feature .

You hear the caller's voice through your telephone's speaker. Continue to speak to the caller through the telephone receiver. Your telephone's microphone is off, so the caller does not hear people in your office.

Canceling Group Listening

Feature

Group Listening is canceled automatically when you hang up or when you press

Feature .



Tip

Keep the receiver away from the speaker, or you may hear feedback. The higher the volume, the more the feedback. Press to prevent feedback when hanging up.

Using Handsfree/Mute

The ability to use Handsfree must be turned on or off for each telephone. The type of Handsfree can be changed. See [Changing Handsfree for a telephone](#) on page 28.

You must turn on Handsfree for a telephone to be able to use a headset.

Answering calls without lifting the receiver

1. Press the line button for the ringing call. (This step is not necessary if you have a prime line assigned to your telephone.)
2. Press . The telephone's internal microphone and speaker are automatically turned on.

Handsfree is not available for a M7100 telephone.





Tip

Direct your voice toward the telephone. The closer you are to the telephone, the easier it is for the microphone to transmit your voice clearly to your listener.

Making calls without lifting the receiver

1. Press . (If you don't have a prime line assigned to your telephone, press a line button.)
The telephone's internal microphone and speaker are automatically turned on.
2. Dial your call.
3. Speak normally.

Muting Handsfree

1. Press  to switch off the telephone microphone so that you can speak privately to someone in your office while you are on a handsfree call.
2. Press  to turn the microphone back on again and continue your handsfree call.

Changing a regular call to handsfree

1. Press .
2. Hang up the receiver.

Changing a handsfree to a regular call

Lift the receiver.

Using Handsfree

The indicator next to  is solid when you have Handsfree turned on. It flashes when you mute the microphone.

Wait for your caller to finish speaking before you speak. The microphone and speaker cannot both be on at once. Your caller's voice may be cut off if you both speak at the same time. Noises such as a tapping pencil could be loud enough to turn on your microphone and cut off your caller's speech.

To prevent a possible echo, keep the area around your telephone free of paper and other objects that might screen your microphone. Turning down the microphone's volume (press the left end of  while speaking) prevents echoes. When you change the volume level, both the microphone and speaker volume are adjusted to prevent feedback problems.

Place the telephone so that any unavoidable local noise (such as an air conditioner) is behind it. This limits the amount of disruptive background noise.



Tip

In open-concept environments, use the receiver when handsfree communication is not necessary or when you need privacy during a call. Another option is to use a headset.

Changing Handsfree for a telephone

You can program the type of Handsfree used with each telephone or activate Handsfree Answerback.

You need to start a Unified Manager session to program this feature. For more information about programming using the Unified Manager, see the *Enterprise Edge Programming Operations Guide*.

There are three ways to set Handsfree for an individual telephone:

Handsfree:None
CHANGE

Handsfree is not available to the telephone.

Handsfree:Auto
CHANGE

You can make or answer a call without having to pick up the receiver or press . The telephone's internal microphone and speaker turn on automatically when you press a line or intercom button to make or answer a call.

Handsfree:Std
CHANGE

A standard version of Handsfree described [Using Handsfree/Mute](#) on page 26.

For other displays, see [Common feature displays](#) on page 125.

Both Auto and standard Handsfree allow you to use a headset with an Enterprise Edge telephone.

A Handsfree/Mute button is automatically assigned to a telephone that is programmed with Handsfree and is always located in the lower right-hand corner of the telephone.

Handsfree Answerback

Handsfree Answerback allows you to answer a voice call without lifting the receiver. It is always turned off for a M7100 telephone.

You can turn Handsfree Answerback on or off for a telephone that is programmed to use Handsfree.

You need to start a Unified Manager session to program this feature. For more information about programming using the Unified Manager, see the *Enterprise Edge Programming Operations Guide*.

Turning Privacy on or off for a call

Feature

Lines in your system can be configured to have automatic privacy. If a line is not programmed with privacy, anyone with the line assigned to their telephone can join your call by pressing the line button. If a line is programmed with privacy, only one person at a time can use the line.

Privacy control cannot be used on internal or conference calls.

When another telephone joins a call, the participants on the call hear a tone, and a message appears on the Enterprise Edge display. You cannot join a call without this tone being heard.

Creating a conference by releasing privacy

If a line is programmed with privacy, you can turn privacy off to allow another person with the same line to join in your conversation and form a conference. All the rules applicable to a conference apply except there is only one line in use, instead of the normal two. This means that you cannot split a conference set up using Privacy.

1. Press Feature .
2. Tell the other person to press the line button and join your conversation.

Only two Enterprise Edge telephones in addition to the external caller can take part in this kind of conference.

Making a call private

If a line is programmed not to have privacy, you can turn privacy on for a call, preventing other people with the same line from joining your conversation.

Press Feature .

Checking call length using Call Duration Timer

Feature

By pressing Feature , you can see how long you spent on your last call, or how long you have been on your present call.

Displays

221 02:47

The display shows the last call you made, or the current call, and the total elapsed time in minutes and seconds.

Line061 01:45





You parked your last call. The display shows the length of time the call was parked. You cannot see the length of time a call was parked unless the call is active at your telephone or has just been released by your telephone.

Disconnecting by accident



If you accidentally drop the receiver back into the telephone cradle while answering a call, you can quickly retrieve the call.

Pick up the receiver again or press  within one second to be reconnected to your call.

Time

Press     to display the current date and time while you are on a call.

There are many ways to make a call, depending on the programming and the type of call, as follows:

- Pick up the receiver and dial. The Enterprise Edge system supports three methods of dialing. See [Changing how you dial your calls](#) on page 34.
- Pick up the receiver, press a line button, and dial (if the call is not on your prime line).
- Press  and dial (to talk without using the receiver). See [Using Handsfree/Mute](#) on page 26.
- Press , press a line button, and dial (to talk without the receiver and if the call is not on your prime line).
- Press a line button and dial (to talk without the receiver and if Automatic Handsfree is assigned to your telephone).
- Use one of the features that make dialing easier. See [Time savers for making calls](#) on page 37.

Displays

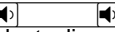
221 busy PRIORITY LATER	The telephone you have called has no internal lines available. Press LATER to use the Ring Again or Message features or press PRIORITY to make a priority call.
9_ QUIT BKSP	You are dialing using Pre-dial. To erase an incorrect digit, press the left end of  or BKSP . When the number is complete, select a line or lift the receiver.
95551234 TRANSFER	This prompt remains on your display as long as you are on a call you have dialed. To transfer the call, press TRANSFER .
Already joined	Your telephone is already connected to the telephone you are trying to call. Check your active line buttons, and return to that call.
Calling 221 PRIORITY LATER	Wait for the telephone to be answered. If no one answers, press LATER to use the Ring Again (page 36) or Message (page 61) feature, or press PRIORITY to make a priority call.
Can't ring again	You cannot use Ring Again on your current call. You can only use Ring Again while you have a busy signal on an internal call or line pool request or while an internal call is ringing.
Do not disturb PRIORITY LATER	The telephone you are calling has Do Not Disturb turned on. Press LATER to use the Ring Again or Messages features, or press PRIORITY to make a priority call.
Expensive route	You have dialed a number, but the least expensive route that the system is programmed to use is busy. Unless you release the call, it goes through on a more expensive route.

Hidden number	The last number you dialed or the number you saved for Saved Number Redial was a speed dial number that displayed a name rather than the number. The number is dialed correctly, but you cannot see it.
Line denied	You have attempted to use someone else's private line.
Line061 TRANSFER	Enter the digits of the number you want to dial.
No last number	You have not dialed an external telephone number since the last power interruption or system reset.
No line selected	Either you have no prime line or your prime line is busy. Select a line manually before dialing.
Not in service	You have entered the number of a telephone that is not in service.
On another call LATER	The telephone you have called is on another call. Press <u>LATER</u> to use the Ring Again or Message features.
Restricted call	The call you are trying to make has been restricted in programming. A possible reason is time-of-day restrictions on certain calls.
Ring Again? YES NO EXIT	Press <u>YES</u> to use Ring Again. Press <u>NO</u> to send a message. See Sending messages on page 61 and Turning on Ring Again on page 36.
Select a line	Either you have no prime line, or the prime line is in use, or the line programmed for an autodial number, speed dial number, or Hotline is in use. Select a line and dial again.
Send message? YES NO	Press <u>YES</u> to send a message. See Messages.

For other displays, see [Common feature displays](#) on page 125.

Choosing a line using a line button

You have one line button for each line assigned to your telephone. Press the line button to select the line you want to answer or use to make a call. Having several line buttons allows you immediate access to more than one line.

The M7100 telephone has two intercom paths which are used instead of line buttons to answer and make calls. Each M7100 can be assigned two lines. You can press to switch between two calls, one active and one on hold.

Line pools

A line pool is a group of external lines that can be shared by many telephones. You can use a line in a line pool to make an external call.

The Enterprise Edge system can have 15 line pools plus 6 PRI pools, and a telephone can be programmed to access any number of them.

A line pool access code is a number you dial to get a line pool. The access code can be up to four digits long. You can have several different line pools for your system, each one giving you access to a different set of external lines. It is one way of sharing lines across telephones in a system.

Your installer programs the line pool access codes and gives each telephone access to a line pool.

Everyone in the office should have a list of the line pool access codes for the line pools their telephones can use.

Using a line pool to make a call

Feature 6 4

1. Press 6 4.
2. Enter a line pool access code.

If you have a free internal line, you can make a call using a line pool without entering the feature code first.

1. Select an internal line (intercom).
2. Dial the line pool access code.



Tip

If no lines are available in the line pool, you can use Ring Again at the busy tone. You are notified when a line in the line pool becomes available. See [Using Ring Again](#) on page 36.

Programming a memory button with a line pool feature code

When you program a button with the line pool feature code, you must enter a line pool access code after the feature code. The programmed line pool button accesses a specific line pool, not the line pool feature. See [Programming feature buttons](#) on page 74 for more information.

If you program a button with an indicator to access a line pool, when all the lines in a line pool are busy, the indicator for the line pool button turns on. The indicator turns off when a line becomes available.

Changing how you dial your calls

Feature * 8 2

1. Press Feature * 8 2.
2. Press # or **NEXT** until the dialing mode you want appears.
3. Press Hold or **OK** to select the displayed dialing mode.

The dialing modes feature code cannot be programmed onto a memory button.

Using Standard dial

Standard dial allows you to make a call by selecting a line and dialing the number. If you have a prime line, it is selected automatically when you lift the receiver or press Handsfree Mute.

You cannot use Standard dial on a M7100 telephone unless you pick up the receiver first. If you have a M7100 telephone, use the Automatic dial or Pre-dial feature for on-hook dialing.

Using Automatic dial

Automatic dial allows you to dial a number without selecting a line. Your prime line is selected as soon as you start dialing a number.

Automatic dial does not work if your telephone has no prime line or if your prime line is in use.

Telephones connected to an Enterprise Edge Analog Terminal Adaptor (ATA2) or an Enterprise Edge Analog Station Module (ASM) cannot use Automatic dial.

Using Pre-dial

Pre-dial allows you to enter a telephone number, check it, then change it before actually making the call. The call is not dialed until you select a line or line pool, or pick up the receiver. You can pre-dial both external and internal numbers. You must, however, select the correct type of line (external or internal) for the type of number you have entered.



Tip

If your telephone starts ringing while you are pre-dialing a number, you can stop the ringing by turning on Do Not Disturb (Feature 8 5). This does not affect numbers you are entering.

You cannot pre-dial a telephone number if all the lines on your telephone are busy.

When the internal number you have called is busy

Priority Call

Feature

If you get a busy signal or a Do Not Disturb message when you call someone in your office, you can interrupt them. Use this feature for urgent calls only.



Tip

Priority calls cannot be made to Hunt Group DNs. For more information on Hunt Groups see [Hunt Groups](#) on page 83.

Making a priority call

1. Press .
2. Wait for a connection, then speak.

A person who receives a priority call while on another call has eight seconds to accept or block the call. For information on blocking calls see [Stopping calls](#) on page 87. If the person does nothing, the priority call feature puts their active call, including conference parties, on Exclusive Hold and connects your call.

Giving a telephone the ability to make priority calls

You need to start a Unified Manager session to program this feature. For more information about programming using the Unified Manager, see the *Enterprise Edge Programming Operations Guide*.

Displays

Call blocked	You tried to place a priority call to another Enterprise Edge telephone. The person you called has blocked your call. Try to call later.
Please wait	The party you are calling has eight seconds to decide whether to accept or reject your priority call.
Priority denied	The telephone you are calling has already received a priority call or is unable to receive priority calls.

You can make a priority call only while your telephone displays:

```
221 busy
PRIORITY    LATER
```

```
Calling 221
PRIORITY    LATER
```

```
Do not disturb
PRIORITY    LATER
```

```
On another call
PRIORITY    LATER
```

Using Ring Again

Feature 2

Use Ring Again when you call someone on your Enterprise Edge system and their telephone is busy or there is no answer. Ring Again can tell you when they hang up or next use their telephone. You can use Ring Again to tell you when a busy line pool becomes available.



Tip

The Ring Again feature cannot be used when calling a Hunt Group DN. For more information on Hunt Groups see [Hunt Groups](#) on page 83

Turning on Ring Again

Feature 2

Press before you hang up.

Using Ring Again cancels any previous Ring Again requests at your telephone.

Canceling Ring Again

Feature # 2

Press to cancel a Ring Again request.

Displays

```
Can't ring again
```

You cannot use Ring Again on your current call. You can only use Ring Again while you have a busy signal on an internal call or line pool request, or while an internal call is ringing.

```
Ring Again?
YES    NO    EXIT
```

Press **YES** to use Ring Again. Press **NO** if you prefer to send a message.

Storing a number on a memory button for Autodial

You can program memory buttons for one-touch dialing of internal or external telephone numbers.

Buttons used for lines, answer or Handsfree/Mute cannot be used as autodial buttons. If the power to your Enterprise Edge system is off for more than three days, autodial numbers (as well as some other system programming) may be lost from the memory.

Adding an autodial button

Feature * 1 or Feature * 2

1. Press Feature * 1 to program an external number or Feature * 2 for an internal number.
2. Choose a button and then enter the number as if you were dialing it.

When programming Autodial you can use:

- Last Number Redial
- Saved Number Redial
- destination codes (choose Intercom as the line)
- host system signalling

Choosing a line for Autodial

To include a line selection for an external number, press the line or intercom button before you enter the number. To select a line pool, press a programmed line pool button, or press Intercom and enter a line pool access code.

If you select a line before pressing the autodial button, the call goes out on the line you have selected instead of the line that is part of the autodialer programming.

For the M7100 telephone, an external autodialer can be programmed only by using a line and not a line pool.



Tip

If you do not include a line selection in an autodial number, the call uses your prime line (if you have one).

Using intercom as the line for Autodial

If you press as the line for an external autodial number, you must include a valid line pool access code or a destination code. If line pool access codes or destination codes are changed, remember to reprogram autodial numbers.

Displays

987_ QUIT BKSP OK	Continue to enter digits until the number is complete. Press <input type="text" value="Left Arrow"/> or <input type="text" value="Right Arrow"/> or BKSP to erase an incorrect digit. Press <input type="text" value="Hold"/> or OK when you are finished.
Autodial full	The memory allotted to autodial numbers in your Enterprise Edge system is full.
Button erased	While programming external Autodial, you erased the button by pressing <input type="text" value="Hold"/> or OK before entering any digits.
Enter digits QUIT OK	Enter the number you want to program (choosing the line first if necessary) exactly as if you were making a call.
Intercom #: _ QUIT	Enter the internal telephone number you want to program.
Invalid number	You are programming an internal autodial button and have entered a number that is not an internal number on your system. Enter a valid internal number. If the number you are entering is a destination code, use external autodial.
Press a button QUIT	Press the memory button you want to program.
Program and HOLD	Enter the number you want to program onto the button, then press <input type="text" value="Hold"/> .
Program and OK QUIT OK	Enter the number you want to program onto the button, then press <input type="text" value="Hold"/> or OK . You may include a line or line pool selection in an autodial sequence by selecting the line before entering any digits.
Programmed	The number is stored on the button.

For other displays, see [Common feature displays](#) on page 125.

Using Last Number Redial

Feature 5

Press Feature 5 to redial the last external number you dialed.

Last Number Redial records a maximum of 24 digits.



Tip

If you have a programmed Last Number Redial button, you can use Button Inquiry (Feature * 0), then press the Last Number Redial button followed by (#) to check the last number before you dial it.

Preventing a telephone from using Last Number Redial

Last Number Redial can be restricted at individual telephones.

You need to start a Unified Manager session to program this feature. For more information about programming using the Unified Manager, see the *Enterprise Edge Programming Operations Guide*.

Displays

Hidden number

The last number you dialed was a speed dial number that displayed a name rather than the number. The number is dialed correctly, but you cannot see it.

No last number

You have not dialed an external telephone number since the last power interruption or system reset.



Tip

You can copy a number onto an autodial button using Last Number Redial.

Using Speed Dial

Enterprise Edge provides two types of speed dialing: system and personal. System Speed Dial programming allows you to assign two-digit speed dial codes to the external numbers your co-workers call most frequently. Personal or User Speed Dial programming allows individuals to program their own speed dial numbers.

Speed dial numbers are subject to the same restriction filters as regularly dialed numbers. Your installer can program system speed dial numbers to bypass dialing restrictions.

Speed dial numbers may include host system signaling codes.

Making a speed dial call

Feature 0

1. Press Feature 0 to quickly dial external telephone numbers that have been programmed onto speed dial codes.
2. Enter the appropriate two-digit speed dial code.

Changing and adding System Speed Dials

System Speed Dial codes are numbered from 01 to 70. The installer assigns numbers to System Speed Dial codes for the entire system.



Tip

There is no difference between using User Speed Dial and using System Speed Dial. They differ only in how you program them.





Adding or changing User Speed Dial

Feature * 4

To add or change a User Speed Dial number on your telephone:



1. Press Feature * 4.
2. Enter a two-digit code from 71 to 94 that you want to associate with a telephone number.
3. To include a line selection for this number, press the line or intercom button. To select a line pool, press a programmed line pool button, or press Intercom and enter a line pool access code. For the M7100 telephone, you can select only a line pool.
4. Enter the number you want to program.
5. Press Hold or **OK**.

Displays

<p>01:9_</p> <p>CANCL BKSP OK</p>	<p>Continue entering the number you want to program. You can change the number by pressing BKSP or  . When you are finished, press  or OK.</p>
<p>Enter digits</p> <p>QUIT OK</p>	<p>Enter the telephone number you want to program exactly as if you were dialing it normally. When you are finished, press  or OK.</p>
<p>Invalid code</p>	<p>You have entered a code outside the code range (01-70 for system, 71-94 for personal).</p>
<p>No number stored</p>	<p>There is no number stored on the speed dial code you have dialed.</p>
<p>Program and HOLD</p>	<p>If you want to program a line or line pool selection for this speed dial number, select the line or line pool. Otherwise, enter the telephone number exactly as if you were dialing it normally. When you are finished, press .</p>
<p>Program and OK</p> <p>QUIT OK</p>	<p>If you want to program a line or line pool selection for this speed dial number, select the line or line pool. Otherwise, enter the telephone number you want to program exactly as if you were dialing it normally. When you are finished, press OK.</p>
<p>Select a line</p>	<p>There is no line associated with the speed dial number you are trying to use. Select a free external line or line pool and enter the speed dial feature code again.</p>
<p>Unknown number</p>	<p>The system cannot dial the number stored. Reprogram the number.</p>

For other displays, see [Common feature displays](#) on page 125.

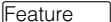
Using Saved Number Redial



You can save the number of the external call you are on (provided you dialed the call) so that you can call it again later. Each telephone can save one number at a time with Saved Number Redial, not one number for each line.



Tip

You can copy a number onto an autodial button using Saved Number Redial.

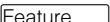
Saving a number

Press    while you are on the call.

Saved Number Redial records a maximum of 24 digits.

Dialing a saved number

Press when you are not on a call.

If you have a programmed Saved Number Redial button, you can use Button Inquiry () to check the last number before you dial it.

Preventing a telephone from using Saved Number Redial

Saved Number Redial can be restricted at individual telephones.

You need to start a Unified Manager session to program this feature. For more information about programming using the Unified Manager, see the *Enterprise Edge Programming Operations Guide*.

Displays

Hidden number

You have saved a speed dial number that displays a name rather than the number. The number is dialed correctly, but you cannot see it.

No number saved

You have tried to save the number of an incoming call. You can only save numbers that you have dialed yourself.

Using Hold

You can temporarily suspend a call by pressing .

When a call is on hold, its indicator flashes on all telephones that have access to the line. The call can be retrieved from any of these telephones.

On the M7100 telephone, alternates between two lines; one active, one on hold. The M7100 telephone cannot retrieve a call placed on hold by another telephone.



Tip

Answered Hunt Group calls can be placed on hold at the answering Enterprise Edge set. For more information on Hunt Groups see [Hunt Groups](#) on page 83.

Retrieving a held call

You can connect to a call on hold by pressing the flashing line button of the held call.

Holding automatically

If your line has been programmed with full autohold, you can switch from one call to another and have your calls put on hold automatically.

Press the line button of the second caller. Your current caller is put on hold automatically.

Listening on hold

If you have been put on hold, you can hang up the receiver while you wait for the other person to return.

1. Press .
2. Hang up the receiver.
3. Press the line button of the call. You may hear indications from the far end that you are on hold (for example, tones or music).

4. When the person returns, that is, you hear them through your telephone speaker, simply lift the receiver to resume the conversation.



Tip

If Automatic Handsfree has been assigned to your telephone, you can use the Handsfree/Mute feature instead of Listen on Hold.

Holding a call exclusively

Feature 7 9

You can put a call on Exclusive Hold so that it can be retrieved only at your telephone.

Press Feature 7 9 or Feature Hold . The line appears busy on all other telephones, and the call cannot be picked up by anyone else in the office.

Displays

On hold: LINENAM

You have placed one or more calls on hold. The name of the line that has been held the longest is displayed.

Using Call Queuing

Feature 8 0 1

If you have more than one call ringing at your telephone, you can choose the call that has the highest priority by pressing Feature 8 0 1 .

Call Queuing answers incoming external calls before callback, camped, and transferred calls.

Using the transfer feature

Feature 7 0

Transfer allows you to direct a call to a telephone in your Enterprise Edge system, within the Enterprise Edge network, or external to Enterprise Edge.

Transferring a call

1. Press Feature 7 0.
2. Call the person to whom you want to transfer the call.
3. If you want to talk to the person, wait for them to answer and speak to them before proceeding.
4. When you are ready to complete the transfer, press Rls or **JOIN**.

You cannot use Last Number Redial, Saved Number Redial, a speed dial code, Priority Call or Ring Again to dial the number for a transfer.

Depending on how a private network call is routed, it may not always be possible for the system to return a transferred call to you if the transferred call is not answered. When transferring a call to a private network destination, stay on the line until the person to whom you are transferring the call answers.

You cannot use the Line Pool feature code to access a line pool for a transfer. To use a line pool, use a programmed line pool button, or press Intercom and enter a line pool access code.

If you have an auxiliary ringer programmed to ring for calls on an external line, and you transfer a call on that line without announcing the transfer, the auxiliary ringer rings for the transferred call.

Transferring external calls

If an external call is transferred to a busy telephone, or not answered after a few rings, the call automatically rings again at the telephone from which it was transferred, and the display indicates that the telephone was busy or that no one answered.

When transferring an external call to an external number, the external call you are trying to transfer must be an incoming call on a disconnect supervised line.

While on a conference call, you can remove yourself from the conference and connect the other two callers using the Transfer feature. However, if both of the other people are from outside the system, at least one of the outside callers must have called you and both of the outside calls must be on disconnect supervision lines.

Note: Transfer via Hold on DID lines is not supported. Once a call is answered the line appearances on all other sets are free immediately to take other calls. This allows a greater number of calls to be received. Use the Call Park feature to transfer a call.

In certain situations, you may experience lower volume levels when transferring an external call to an external person, or when transferring two external callers from a conference call.

Canceling a transfer

You can reconnect to the person you are trying to transfer at any time before the transfer is complete.

1. Press # 7 0 or **CANCL**.
2. If you are not reconnected to your original call, press and then press the line key of the original call, which is now on hold.

Displays

221>222 CANCL RETRY JOIN	You are talking to the person you want to transfer the call to. Press RETRY if you decide to transfer the call to someone else. Press <input type="text" value="Ris"/> or JOIN to transfer the call.
221 no reply CALLBACK	The person to whom you tried to transfer a call did not answer. Press CALLBACK or the flashing line button to reconnect to the call. On the M7100 telephone, lift the receiver.
Do not disturb CANCL RETRY JOIN	The person to whom you tried to transfer a call has Do Not Disturb active on their telephone. Press JOIN to transfer the call anyway. Press RETRY to transfer the call to someone else. Press CANCL or the flashing line button to reconnect to the call (on the M7100 telephone, press <input type="text" value="Feature"/> # 7 0).
Invalid number CANCL RETRY	You entered an invalid internal number. Press RETRY and enter the number again.
Line061 hung up	The external caller you were transferring hung up before the transfer was complete.
Line061>221 CANCL RETRY JOIN	Press JOIN to transfer the call on line 061 to telephone 221. Press RETRY if, after talking to the person at extension 221, you decide to transfer the call to someone else.
Not in service CANCL RETRY	The telephone to which you are trying to transfer a call is out of service.

Restricted call CANCL RETRY	You cannot transfer the call because of telephone or line restrictions.
Still in transfer CANCL RETRY	Complete the transfer in progress before you access a new feature, answer another alerting call or select an outgoing line.
Transfer denied CANCL RETRY	Your transfer cannot be completed for one of these reasons: All the resources needed to perform a transfer are in use. Try again later. You have tried to transfer an external call to another external party. Some restrictions apply. You cannot transfer your conference call.
Transfer to:2_ CANCL RETRY	Press RETRY if you entered the wrong internal number or if the person to whom you are transferring the call is unavailable.

For other displays, see [Common feature displays](#) on page 125.

Using Camp-on

Feature

You can transfer an external call to another telephone, even if all of its lines are busy.

1. Press .
2. Dial the number of the telephone to which you want to camp the call.

Camped calls appear on a line button on the receiving telephone, if one is available. If there is no line button available, you receive a message on the display and hear Camp tones.

Each Enterprise Edge telephone can handle only one camped call at a time.

Displays

221 CAMP max CALLBACK	You tried to camp a call to a telephone that already has a camped call. The call has come back to you. Press the CALLBACK button or the line button to reconnect to the call. On the M7100 telephone, just pick up the receiver.
221 DND CALLBACK	The person to whom you redirected a call has Do Not Disturb active on the telephone. The call has come back to you. Press the CALLBACK button or the line button to reconnect to the call. On the M7100 telephone, just pick up the receiver.
CAMP denied	You have tried to camp an internal call. You can only camp external calls.
CAMP to: CANCL	Dial the number of the internal telephone to which the call is sent.

Camped: 221 CALLBACK	The telephone to which you camped a call did not answer the call. The call has come back to you. Press CALLBACK or the line button to reconnect to the call. On the M7100 telephone, just pick up the receiver.
Line061 hung up	A call you camped has come back to you, but the caller hung up before you could reconnect.
Not in service CALLBACK	The telephone to which you have camped a call is out of service or is being used for programming. The call has come back to you. Press CALLBACK or the line button to reconnect to the call. On the M7100 telephone, just pick up the receiver.
Release a call	The line that the camped call is on is in use or that line does not appear at your telephone. Release the line or release an internal line.

For other displays, see [Common feature displays](#) on page 125.

Parking a call

Feature

You can suspend a call so that it can be retrieved from any telephone in your system.

1. Press Feature .
2. Use the Page feature (Feature) or press **PAGE** to announce the retrieval code displayed by your telephone.

Retrieving a parked call

1. Select an internal line. (On the M7100 telephone, pick up the receiver.)
2. Dial the Call Park retrieval code.

Using Call Park

When you park a call, the system assigns one of 25 codes for the retrieval of the call. These codes consist of the Call Park prefix, which may be any digit from 1 to 9, and a two-digit call number between 01 and 25. For example, if the Call Park prefix is 1, the first parked call is assigned Call Park retrieval code 101.

The Enterprise Edge system assigns Call Park codes in sequence, from the lowest to the highest, until all the codes are used. This round-robin approach means that a greater variety of codes are used, which makes it easier for a call to reach the right person when more than one incoming call is parked.

The highest call number (the Call Park prefix followed by 25) is used only by analog telephones or devices connected to the system using an Enterprise Edge ATA2 or an Enterprise Edge ASM. Analog telephones or devices cannot use the other Call Park codes.

Your installer programs both the Call Park prefix and the delay before parked calls are returned to the originating telephone. External calls parked for longer than the programmed delay are returned to your telephone.



Tip

Answered Hunt Group calls are parked in the same manner as other calls. For more information on Hunt Groups see [Hunt Groups](#) on page 83.

Call Park can be disabled by your installer.

Displays

Already Parked	The person you were talking to has already parked your call. You cannot park the same call.
No call to park	You have attempted to use Call Park with no active call on your telephone. If the call you want to park is on hold, reconnect to it before you park it.
Invalid number	You have entered an invalid retrieval code.
No call on: 101	There was no call on the retrieval code you entered.
Park denied	You have tried to park a conference call. Split the conference and park the calls separately. The person who retrieves the calls can reconnect the conference.
Parked on: 402 PAGE EXIT	Record the code shown. Use Page (<input type="text" value="Feature"/> 6 0) or press <u>PAGE</u> to announce the call and its retrieval code.
Parking full	All available retrieval codes are in use. Transfer the call or take a message instead.

For other displays, see [Common feature displays](#) on page 125.

Using Callback

When you direct a call you have answered to another telephone, the system monitors the call to make sure it is answered. If no one answers the call within a set length of time, the system directs it back to you.

Callback generates a variety of displays. Most occur after a set delay and are listed in the index. Some occur immediately if the telephone to which you are directing a call is out of service or otherwise unavailable. These are listed with the descriptions of the specific features such as Transfer or Camp-on.

Forwarding your calls to another telephone

Feature 4

Press Feature 4 and enter the number of the telephone to which you want your calls forwarded. You can forward your calls to an internal or external telephone. To forward your calls to an external destination you must enter the route plus the dialing digits of the external telephone. For example, if your system requires you to dial 9 for external calls then you must enter 9 plus the dialing digits to forward your calls to an external number.

You can also use Line Redirection to forward calls outside the system. Line redirection takes precedence over Call Forward.

Canceling Call Forward

Press Feature # 4.

Using Call Forward at your telephone

When you use Feature 4, all calls go to the destination you select, regardless of how Forward on busy and Forward no answer are programmed.

To allow external destination programming you need to start a Unified Manager session. Allow redirect must be set to Yes for each set. For more information about programming using the Unified Manager, see the *Enterprise Edge Programming Operations Guide*.



Tip

If your Enterprise Edge set is a member of a Hunt Group, the Call Forward all calls setting is overridden by the Hunt Group routing for Hunt Group calls. For more information on Hunt Groups see [Hunt Groups](#) on page 83.

If the telephone to which you forwarded your calls does not have the same external lines as your telephone, the forwarded calls appear on intercom buttons.

If a call is forwarded, it does not ring but the line indicator flashes on your telephone. You can answer the call by pressing the button next to the flashing indicator.



Tip

If you are one of a group of people who regularly forward their calls to one another, be aware that it is possible to set up forward loops where a call is forwarded from one telephone to another in a circle, and is never answered anywhere.

Overriding Call Forward

If you call someone who has their calls forwarded to you, your call rings at that person's telephone even though they are forwarding their calls to you.

Changing the automatic Call Forward settings for a telephone

Call forwarding can be programmed to forward a call when it is not answered or the line is busy. You can also define the number of times the telephone rings before forwarding takes place. These features must be programmed by starting a Unified Manager session.

Changing Forward no answer

Forward no answer redirects unanswered calls to another telephone on your Enterprise Edge system.



Tip

If the Enterprise Edge set is a member of a Hunt Group, the Call Forward no answer feature is overridden and the Hunt Group call continues to ring until the hunt time has expired. For more information on Hunt Groups see [Hunt Groups](#) on page 83.

Line Redirection takes precedence over Forward no answer.

For more information about changing Forward no answer using the Unified Manager, see the *Enterprise Edge Programming Operations Guide*.

Changing the delay before a call is forwarded

You can assign the number of times that the incoming call rings at your telephone before the call is forwarded. To estimate the delay time in seconds, multiply the number of rings by six.

For more information see the *Enterprise Edge Programming Operations Guide*.

Forward on busy

Forward on busy redirects your calls to another telephone on your Enterprise Edge system when you are busy on a call, or when you have Do Not Disturb activated at your telephone. For more information about changing Forward on busy using the Unified Manager, see the *Enterprise Edge Programming Operations Guide*.

Line Redirection takes precedence over Forward on busy. Calls that are redirected by Line Redirection are not affected by any Call Forward features or Call Forward programming.

Telephones that have Forward on busy active can receive priority calls. If you are busy on a target line call, another call to that target line is redirected to the prime telephone for that target line.



Tip

If the Enterprise Edge set is a member of a Hunt Group, the Call Forward on busy feature is overridden and the Hunt Group call continues to ring until the hunt time has expired. For more information on Hunt Groups see [Hunt Groups](#) on page 83.

DND on Busy

When you are busy on a call and a second call comes in, your telephone rings softly to alert you to the second call. If you find this second ring distracting, you can have the system prevent a second call from disturbing you by assigning Do Not Disturb (DND) on Busy to your extension.

When DND on Busy is turned on for the set, internal and private network callers hear a busy tone instead of ringing when you are on the telephone. External callers are transferred to the prime set used in your system. For more information about changing Do Not Disturb on Busy using the Unified Manager, see the *Enterprise Edge Programming Operations Guide*.

If you use DND on Busy, the line indicator for an external incoming call flashes, but your telephone does not ring.

Forward on busy takes priority over DND on Busy.

If an external call uses a target line, the call is processed according to the programming of the target line. If the target line is busy, the caller may hear a busy tone or be routed to the prime set for the target line regardless of the DND on Busy programming for the telephone.



Tip

If an Enterprise Edge set is a member of a Hunt Group and the set activates this feature, the set does not receive notification of incoming Hunt Group calls while on a call. The DND on busy feature overrides the Hunt Group. For more information on Hunt Groups see [Hunt Groups](#) on page 83.

Call Forward and voice mail

If you want a voice mail system to pick up unanswered calls automatically

- use the internal number of your voice mail as the destination when you program Forward no Answer and Forward on busy
- or
- make the ring delay greater than the delay used by your voice mail system, if your voice messaging system or service automatically retrieves calls

Displays

Forward denied	There are several reasons why you may get this message. For instance, you cannot forward your calls to a telephone that has been forwarded to your telephone.
Forward>221 CANCL	Your calls are being forwarded to telephone 221.
Not in service	Two or more telephones are linked in a forwarding chain, and one of them is out of service or is being used for programming.

For other displays, see [Common feature displays](#) on page 125.

Line Redirection

Line Redirection allows you to send your external calls to a telephone outside the office. You may choose to redirect all your external lines or only some of them.

Line Redirection takes precedence over the Call Forward feature. If both features are active on a set, incoming external calls on redirected lines are routed to the specified Selective Line Redirection (SLR) external destination. Incoming internal calls are forwarded to the specified Call Forward destination.

You cannot use the Line Redirection feature on either a M7100 telephone or a telephone connected to an Enterprise Edge ATA2 or an Enterprise Edge ASM.

Turning on Line Redirection

Feature 8 4

1. Press 8 4.
2. Select the outgoing line to be used for redirected calls.
3. Enter the number to which calls are redirected (the ways you can do this are listed below).
4. Select the lines to be redirected.

Enter the telephone number to which you want to redirect calls, using one of the following methods:

- Press an external autodial button.
- Enter an external telephone number (using no more than 24 digits) then press or **OK**.
- Press or **OK** if the line you have chosen as the outgoing line is a private network line that does not require you to dial digits.

If you use **ALL** to redirect all your lines, it is important that you wait until all the lines on your telephone light up before pressing **Hold** or **OK**. If you press **Hold** or **OK** before all the lines light up, those lines not lit are not redirected.



Tip

The line chosen for redirecting calls on other lines can be used normally when it is not busy on a redirected call. To avoid redirection failing because the chosen line is in use, choose a line pool with several lines in it.

The system does not check that the number you give for line redirection is a valid one. If you redirect to an invalid number, redirection fails. Using an autodial button to enter the redirection number helps avoid this possibility. An autodial button used for line redirection must be programmed to use a specific line.

Canceling Line Redirection

Feature # 8 4

1. Press **Feature** # 8 4.
2. Select the lines you no longer want to be redirected.

Allowing a telephone to redirect calls

You can turn a telephone's ability to redirect calls on and off.

You need to start a Unified Manager session to program this feature. For more information about programming using the Unified Manager, see the *Enterprise Edge Programming Operations Guide*.

Turning the redirect ring for a telephone on or off

You can program a telephone to ring briefly (200 milliseconds) when a call is redirected on one of its lines.

You need to start a Unified Manager session to program this feature. For more information about programming using the Unified Manager, see the *Enterprise Edge Programming Operations Guide*.



Tip

If a telephone has redirect ring enabled, it rings briefly for redirected calls on one of its lines even if another telephone set up the line redirection.

Displays while redirecting lines

Intercom	You selected the intercom button as the facility on which to place the call. Enter a line pool code or a destination code.
Line Redirection QUIT ADD REMOVE	Press * or ADD to begin redirection. Press # or REMOVE to cancel a previous redirection.
No line to use	You have one external line on your telephone, but you need a second line to perform line redirection. Redirect your external line using a line pool as the outgoing line.
Outgoing line	You are attempting to redirect a line and the line you have chosen is the outgoing line you have selected as a destination. You cannot redirect a line to itself. Select another line.
Pool code: __ QUIT	Enter a valid line pool access code.
Redir by 221 OVERRIDE	You have attempted to redirect a line, but someone else has already redirected that line. Press * or OVERRIDE to override the previous redirection and redirect the line as you want.
Redirect denied	You can redirect calls only on individual lines.
Select line out QUIT	Select the line that is used to redirect calls out of the system.
Select line(s) QUIT ALL	Press the lines to be redirected. To undo a line selection, press it again. Press ALL to redirect all your lines.
Select line(s) ALL OK	Continue to press the lines to be redirected. Press Hold or OK when you are finished.
Unequipped line	The line you are attempting to redirect cannot be redirected because the hardware does not support redirection.

Displays while canceling redirection

Select line(s) QUIT ALL	Press the lines that are no longer to be redirected. The lines light up as you press them. Once you cancel redirection for a line you cannot restore it by pressing the line again. Press ALL to cancel redirection for all your lines. When you are finished, press Hold or OK .
Select line(s) ALL OK	Continue to press the lines that are no longer to be redirected. Press Hold or OK when you are finished.

For other displays, see [Common feature displays](#) on page 125.

How Line Redirection is different from Call Forward

Call Forward forwards all calls that arrive at a particular telephone to an internal or external telephone. Line Redirection redirects only the lines you specify, no matter which telephones they appear on, to a telephone outside the Enterprise Edge system. Line Redirection takes precedence over Call Forward.

Using Line Redirection

You redirect lines at a telephone, but once redirected, the lines are redirected for the entire system.

You can redirect only lines that appear at line buttons on your telephone.

You can answer the telephone if it rings while you are in the middle of programming Line Redirection, but none of the Enterprise Edge call handling features are available until the feature times out. If you need to use an Enterprise Edge feature to process the call, quit Line Redirection programming by pressing . Do not press or you disconnect the call you are trying to process.

While you are programming Line Redirection you do not receive any indication of calls that do not actually ring at your telephone.

Be careful to avoid redirection loops. If for example, you redirect your lines to your branch office and your branch office redirects its lines to you, you can create a redirection loop. If these calls are long distance, you end up paying charges.

In certain situations, callers may experience lower volume levels when you redirect calls to an external location.

Paging

Feature 6 0

Paging allows you to make announcements over the Enterprise Edge system using the telephone speakers, or your loudspeaker system, if one is available.

Making a page announcement

1. Press Feature 6 0.
2. Choose a page type. Page types are:
 - 1 through the telephone speakers (internal page)
 - 2 through an external speaker (external page)
 - 3 both internal and external (combined page)
3. If necessary, choose a zone.
4. Make your announcement.
5. Press Rls.



Tip

Instead of entering the Page feature code followed by the page type, you can enter the following shortcut codes.

Page zone 0 is all zones.

Internal	Feature <input type="text"/> 6 1	and zone (0 to 6)
External	Feature <input type="text"/> 6 2	(code 2 has no zones)
Combined	Feature <input type="text"/> 6 3	and zone (0 to 6)

Activating and deactivating the ability to page

You need to start a Unified Manager session to program this feature. For more information about programming using the Unified Manager, see the *Enterprise Edge Programming Operations Guide*.

Creating page zones

Each telephone can be assigned to one of six zones for receiving pages.



Tip

Hunt Group DNs cannot be included in a page zone. For more information on Hunt Groups see [Hunt Groups](#) on page 83.

You need to start a Unified Manager session to program this feature. For more information about programming using the Unified Manager, see the *Enterprise Edge Programming Operations Guide*.

You can make a telephone part of a page zone only if the telephone has paging set to **Y** (Yes).

A zone is any set of Enterprise Edge telephones that you want to group together for paging, regardless of their location. The maximum number of sets in a page zone is 50.

Your installer programs whether a tone sounds before a page begins, and the maximum number of seconds a page can last before it is automatically turned off.



Tip

Make sure that everyone who needs to make page announcements has a list showing which telephones are in which page zones.

Displays

Enter zone:_
ALL

Enter the desired page zone number (0- 6) or press ALL.

Invalid zone

You have entered a page zone code that is not between 0 and 6.

Page choice:
SETS SPKR BOTH

Select the type of page you want. See the list in [Making a page announcement](#) on page 59.

Page timeout

The time allotted for paging has expired.

Paging ALL

You are making a page. The display shows the page zone you have chosen. Press or when you are finished.

Paging busy

A page is already being made in the page zone you have requested.

For other displays, see [Common feature displays](#) on page 125.

**Tip**

You can make an announcement to one person by placing a voice call to their telephone.

Using Page with external paging equipment

When you make a page that uses external paging equipment (external page or combined page), the Long Tones feature is automatically activated for the external paging system only. This allows you to control optional equipment with the Long Tones feature.

Sending messages

The Messages feature allows you to leave a message on the display of another Enterprise Edge telephone or to analog telephones connected to an Enterprise Edge Analog Station Module (ASM). The Messages feature indicates if you have any messages waiting.

The Messages feature uses a message waiting list to keep a record of your internal messages and your (external) voice mail messages (if you subscribe to Enterprise Edge Voice Messaging service with visual message waiting indication).

Sending a message

You can leave a message on the display of another telephone in your Enterprise Edge system.

You can send up to four messages to different telephones, including your message center. If your telephone is a direct-dial telephone or an Enterprise Edge CAP, you can send up to 30 messages.

Only the designated direct-dial telephone for an analog telephone connected to an Enterprise Edge ASM can send messages to analog telephones by pressing . Depending on the programming setup, the analog telephone provides either a Stuttered Dial Tone or a Message Waiting Lamp to inform the user of messages pending.

If your reply to a message is forwarded or is answered at another telephone using the Call Pickup feature, the message remains on your telephone until you cancel it or successfully contact the telephone that sent the message.

For analog telephones connected to an Enterprise Edge ASM, the message waiting indicator remains on until the user invokes . If the analog telephone has the Message Reply Enhancement feature set to Yes, the message waiting indicator is turned off automatically after the reply call is answered no matter from where the call is answered.

For more information on the Message Reply Enhancement feature, see the *Enterprise Edge Programming Operations Guide*.

1. Press **Feature** **1**.
2. On a telephone with a two-line display, press **RED**. (This step is not necessary on a telephone with a one-line display.)
3. Enter the internal number of the person to whom you want to send the message. The person's display reads **Message for you**.
4. On analog telephones connected to an ASM, the message waiting indicator is activated.

Canceling a message you have sent

1. Press **Feature** **#** **1**. The display reads **Cancel for:**.
2. Enter the internal number of the person to whom you sent the message.

Viewing your messages

Feature **6** **5**

You can receive up to four messages from different telephones, including your message center. A single message from your message center may pertain to several messages.

On a telephone with a one-line display

1. Press **Feature** **6** **5**. The display shows the first message.
2. Press ***** or **#** to move through your messages.

On a telephone with a two-line display

1. Press **MSG**. The display shows the first message you received.
2. Press **NEXT** to move through your messages.

Replying to a message

You can call the person (or your message center) who sent a message while you are viewing the message.

On a telephone with a one-line display

- Press **0**.

On a telephone with a two-line display

- Press **CALL**.

If you want to call your message center using a line other than the programmed line, exit your message list and dial the message center telephone number using normal dialing methods.

Replying to a message using an analog telephone connected to an ASM

On an analog telephone connected to an ASM

- Press **Link** ***** **6** **5**. The system automatically retrieves and connects the user to the oldest message sender. (The message can originate from either the designated direct-dial telephone or the internal voice mail system.)

If the analog telephone has the Message Reply Enhancement feature set to Yes, and the sender is the designated direct-dial telephone, the message waiting indicator is turned off automatically after the reply call is answered, no matter from where the call is answered.

For analog telephones connected to an ASM, using the Message Waiting Reply feature (**Link** ***** **6** **5**), retrieves only internal messages sent to the user.

Analog telephones connected to an ASM cannot retrieve external messages by using the Message Waiting Reply feature (**Link** ***** **6** **5**). For external messages, users must call back the external voice mail center to retrieve their messages. When doing so, the message waiting indicator on the analog telephone is turned off automatically.



Tip

If Enterprise Edge Voice Messaging is not installed, only the designated direct-dial telephone can send messages to an analog telephone connected to an ASM using **Feature** **1**. The analog telephone can in turn invoke a single digit access code to reach the designated direct-dial telephone and retrieve messages.

If the designated direct-dial telephone of an analog telephone connected to an ASM is changed, messages sent by the previous designated direct-dial telephone are kept in the incoming message list of the analog telephone until they are retrieved.

Removing items from your message list

You can erase a message while you are viewing it in your message list. If the message is from your message center, this only erases the message notification at your telephone. You need to erase the message at your message center. Refer to your message center documentation.

On a telephone with a one-line display

- Press **Hold**.

On a telephone with a two-line display

- Press **ERASE**.

Removing items from your message list using an analog telephone connected to an ASM

To remove both internal and external messages on an analog telephone connected to an ASM

- Press # to invoke the Cancel Message Waiting feature.

On analog telephones connected to an ASM, the Cancel Message Waiting feature cancels the oldest message received. The system no longer provides either a Stuttered Dial Tone or a Message Waiting Lamp if there are no messages pending.

Viewing messages you have sent

On a telephone with a two-line display, you can view the messages you have sent.

1. Press .
2. Press SHOW to display your first sent message.
3. Press NEXT to move through your sent messages.

Displays

Cancel denied	You have entered an invalid number when attempting to cancel a message.
Cleared>LINENAM NEXT	You have cleared an external message from your message waiting list. The message itself exists in your message center until you erase it there.
In use: 221	You are trying to call from your message waiting list. The line that you are trying to use is being used by the identified Enterprise Edge user.
L061:LINENAMMSG NEXT CALL CLEAR	You are viewing your message list. The display shows the number and name of the line that was used for your message.
Message denied	You have tried to send a message to an invalid internal number or to a telephone that is out of service.
Message list SHOW ADD EXIT	SHOW appears only if you have outstanding messages. Press <u>SHOW</u> to review messages you have sent. Press <u>ADD</u> to send a new message.
Message to:	Enter the internal number of the telephone to which you want to send a message.
Messages & Calls MSG CALLS	You have one or more messages and one or more new Call Logs. Press <input type="text" value="Feature"/> <input type="text" value="8"/> <input type="text" value="0"/> <input type="text" value="6"/> to change the first line of the display to the current time and date.

No button free	You have no line button free with which to reply to a message.
No number stored	There has been no number programmed for the message center. Contact your voice messaging service provider.
Start of list NEXT	You are at the beginning of your list of messages. Press NEXT to move through your messages.
Their list full	You are trying to send a message to a user whose message waiting list is full.
Your list full	You have tried to send a message but your telephone's list of sent messages is full. Cancel one of the messages you have sent, if possible, or wait until you have received a reply to one of those messages.

For other displays, see [Common feature displays](#) on page 125.

Using Voice Call

Feature 6 6

You can make an announcement or begin a conversation through the speaker of another telephone in the system.



Tip

Hunt Groups cannot accept voice calls. Answer buttons have no appearances for voice calls, and the set does not ring for voice calls. For more information on Hunt Groups see [Hunt Groups](#) on page 83. For more information on Answer buttons see [Answer buttons](#) on page 22.

Making a Voice Call

Press 6 6 .

Muting Voice Call tones

When a voice call begins at your telephone, you hear a beep every 15 seconds as a reminder that the microphone is on. To stop it from beeping, pick up the receiver or press .

Answering a Voice Call without touching your telephone

If Handsfree Answerback is assigned to your telephone, you can respond to a voice call without touching the telephone. Handsfree Answerback is not available to the M7100 telephone.

When someone makes a voice call to you, simply start talking. Your telephone's microphone picks up your voice. Once you have answered a voice call, you can put it on hold, transfer it, or otherwise treat it as a normal call.

Preventing Voice Calls to your telephone using Voice Call Deny

Press . Voice calls ring like regular internal calls. Your other calls proceed normally.

Canceling Voice Call Deny

Press .

Displays.

Dial voice call	Dial the internal number or press the internal autodial button of the person to whom you want to speak.
Microphone muted	Your handsfree microphone is muted. Press <input type="text" value="Handsfree Mute"/> or pickup your receiver to respond to the voice call.
No voice call	The telephone receiving the call cannot accept voice calls for one of the following reasons: it is active or ringing with another call; Call Forward is turned on; Do Not Disturb is turned on; Voice Call Deny is turned on; it is not an Enterprise Edge telephone. Your call proceeds automatically as a regular ringing call.
Voice call	The line is open for you to speak.

Using Call Log

Telephones can automatically log Call Display information for calls on an external line. The line must appear on that telephone but it does not have to be a ringing line.

If your system is equipped with the appropriate equipment and you have subscribed to the call information feature supplied by your service provider, you are able to capture information about incoming callers in your call log. The same feature is supplied by an ISDN service package that comes with calling line identification (CLID).

Call Log creates a record of incoming external calls. For each call the log can contain:

- sequence number in the Call Log
- name and number of the caller
- indication if the call was long distance
- indication if the call was answered (and identity of who answered it)
- time and date of the call
- number of repeated calls from the same source
- name of the line on which the call came

Call Log can help you to

- keep track of abandoned or unanswered calls
- track patterns for your callers (for example volume of calls and geographical location of calls)
- record caller information quickly and accurately
- build a personal telephone directory from log items

The long distance indicator and the caller's name and number, may not be shown in the log, depending on the Call Display services provided by your local telephone company and the caller's local telephone company.

To use the features on the following pages, your telephone must have spaces available in its Call log. Your installer programs each telephone with an appropriate number of spaces.

Call Log options

Feature * 8 4

You can select the type of calls to be stored in your Call Log. Choose from four Autolog options: No one answered, Unanswered by me, Log all calls, No autologging.

1. Press Feature * 8 4. The display shows the current option.
2. Press # or NEXT to change the option.
3. Press Hold or OK to select the display option.

Logging a call manually

Feature 8 1 3

If your calls are not automatically logged, you can manually log call information when you are connected to an external call. Storing information for your current call can be helpful in many situations. For example, you may want to

- record a caller's information without using paper and pencil
- record only selected calls that you choose, as opposed to using Call Log automatically
- quickly record caller information before a caller hangs up

Press Feature 8 1 3 to log an external call manually.

Deleting old log items

Feature 8 1 5

Your log has a set number of items that it can hold. When it becomes full, new calls cannot be logged. When your log is full, Autobumping automatically deletes the oldest Call Log item when a new call is logged.

Press Feature 8 1 5 to enable autobumping.

Press Feature # 8 1 5 to disable autobumping.

Viewing your Call Log



Feature 8 1 2

To view your log:

1. Press Feature 8 1 2. The display shows the number of previously read items (old) and the number of new, unread items (new) in the log.
2. Press * or OLD to view old items; press # or NEW to view new items.
3. Press 0 or RESUME to display the last item you viewed, the last time you viewed your Call Log.



Names and numbers for external callers are displayed only if you have subscribed to Call Display services from your local telephone company.

Viewing a Call Log item

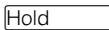

Press   or **MORE** to view the information for a call log item.

Erasing log items

You should routinely erase log items that you've read, to make space for new items in your log.

1. Display the item you want to erase.
2. Press  or **ERASE**.
3. Press  to exit.

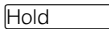

If you accidentally erase an item, you can retrieve it.

1. Press  or **UNDO** immediately after accidentally erasing an item.
2. Press  to exit.

Making a call using Call Log

You may find it helpful to place calls from within your Call Log. The number stored for each call may vary depending on the type of call. For example, if the call was placed from a Centrex or PBX system, the first few numbers may need to be trimmed before you can make the call. If the number you want to call is long distance, or if you want to use a line pool, you may need to add numbers.

To place a call:

1. Display the log item for the call you want to place.
2. Display the associated telephone number.
3. Press   or **TRIM**, once for every digit that you want to remove.
4. Dial any extra digits required.
5. Press an external line or line pool button.
6. Lift the receiver. (This is not necessary if Handsfree is programmed at your telephone.) The displayed number is dialed.

Creating a password to your Call Log

Feature * 8 5

To access your Call Log through a password:

1. Press Feature * 8 5. The display reads **New Password:**.
2. Enter your four-digit password. The display reads **Repeat New:**.
3. Re-enter your four-digit password. The display reads **Password changed**, which confirms that your password has been assigned.

To enter Call Log using your password:

1. Press Feature 8 1 2 to enter Call Log. If you have programmed a password, the display reads **Password:**.
2. Enter your four-digit password.

If you forget your Call Log password, it can be deleted in programming from the Unified Manager. For more information about programming using the Unified Manager, see the *Enterprise Edge Programming Operations Guide*.

Changing your Call Log password

Feature * 8 5

1. Press Feature * 8 5. The display reads **Old Password:**.
2. Enter your old password. The display reads **New Password:**.
3. Enter your new four-digit password. The display reads **Repeat New:**.
4. Re-enter your password. The display reads **Password changed**, which confirms that your password has been changed.

Deleting an assigned password

Feature * 8 5

1. Press Feature * 8 5. The display reads **Old Password:**.
2. Enter your old password. The display reads **New Password:**.
3. Press Hold or **OK**. The display reads **No Pswd assigned**, which confirms that your password has been deleted.

Programming a telephone to log calls automatically

Your installer can program each telephone to automatically log calls coming in on a line.

Displays

1:Unknown name NEXT ERASE MORE	The caller's name is unavailable.
1:Unknown number NEXT ERASE MORE	The caller's number is unavailable.
12:KATE SMITH NEXT ERASE MORE	_ indicates a new item.
12KATE SMITH NEXT ERASE MORE	⌋ indicates that the call was answered.
12SKATE SMITH NEXT ERASE MORE	⌋ indicates a long distance call.
49/1234567890123 NEXT ERASE MORE	✓ indicates that the stored number has been shortened to its final 11 digits. Press ⏪ or ⏩ or MORE to display additional information about the call.
Call(s) bumped NEXT ERASE MORE	One or more log entries have been deleted by the Autobumping feature while you are looking at the Call Log.
Hold or release NEXT ERASE MORE	Hold or release your active call before entering Call Log.
In use: SETNAME NEXT ERASE MORE	The external line is in use.
Jan 4 9:00a 3X NEXT ERASE MORE	The repeat call counter, shown along with time and date, indicates the number of calls you have received from the same caller.
Line061 ⌋227 NEXT ERASE MORE	This call was answered at another telephone (227).
Line061 ⌋Logit NEXT ERASE MORE	This call was logged manually.
Line061 NEXT ERASE MORE	This call was not answered.
Messages & Calls MSG CALLS	There are one or more items in your message waiting list, and there are one or more new items in your Call Log. Press Feature 8 0 6 to change the first line of the display to the current time and date.

New calls begin	You have viewed your last old log item and now view your new log items.
No info to log	No information is available for the call.
No log assigned	No log space has been assigned to the telephone.
No resume item	The resume item has been removed because of Autobumping, repeat call update, or log reallocation while you are looking at the Call Log.

For other displays, see [Common feature displays](#) on page 125.

Using voice mail

If you subscribe to Enterprise Edge Voice Messaging, you can access that service through your Enterprise Edge system. Note that a software keycode is required for Enterprise Edge Voice Messaging. Your installer programs your Enterprise Edge telephone to indicate when you have a voice message waiting on a particular line.

Finding out what a button does using Button Inquiry

Feature * 0

You can check the function of any line, intercom, or programmed button on your Enterprise Edge telephone by pressing Feature * 0. On the M7100 telephone Button Inquiry shows your internal number followed by the function assigned to your single memory button.

Displays

```
061 <LINENAME>
    SHOW      OK
```

The display shows the number and name of the line. Press SHOW to view the redirection status of the line.

```
123456789012345...
    VIEW→    OK
```

Press # or press VIEW→ or ←VIEW to view a number that is too long to fit on the display. Press Hold or OK when you are done.

```
221 <SETNAME>
NEXT  VIEW→
```

The display shows the directory number of the telephone, and the assigned name. Press NEXT to see the first line assigned to ring at the intercom button.

```
<Feature name>
    SHOW      OK
```

The name of the feature assigned to a button is displayed when you press the button. Press # or SHOW for additional information.

```
Press a button
EXIT
```

Press the button you want to check. Press Feature or EXIT when you are finished.

For other displays, see [Common feature displays](#) on page 125.

Making the display darker or lighter using Contrast adjustment

Feature * 7

1. Press Feature * 7.
2. Press a number on the dial pad to choose the contrast level you prefer.
3. Press Hold to save your setting.

On a two-line telephone, you can use the UP and DOWN display buttons to adjust the contrast. The number of contrast levels available varies from one telephone model to another.

Changing the language on the display

You can select the language used on the display of each Enterprise Edge telephone. Enterprise Edge software supports three languages: English, French and Spanish. Button caps are available for each language. When your system is first installed, all telephones use English.

If you program * 5 0 1 on to a memory button, you can press that button until the language you want appears on the display. You cannot program * 5 0 2 or * 5 0 3 onto a memory button.

English

Press * 5 0 1 .

French

Press * 5 0 2 .

Spanish

Press * 5 0 3 .

Programming a feature code onto a memory button

You can program a feature code onto a memory button. In some cases, pressing the button a second time cancels the feature.

Programming feature buttons

* 3

Any memory button not programmed as an external or internal line, target line, Answer button, or Handsfree/Mute button, is available for features.

1. Press * 3 .
2. Press the memory button you want to program with a feature.
3. Enter the appropriate feature code you want to assign onto the button.

The following feature codes cannot be programmed onto a memory button: Long Tones and any code beginning with * except * 5 0 1 (Language Choice) and * 7 (Contrast Adjustment).



Tip

When you program a button with the line pool feature code, you must enter a line pool access code after the feature code. The programmed line pool button accesses a specific line pool, not the line pool feature.

Erasing a feature button

1. Press * 1 .
2. Press the feature button.
3. Press or **OK** to erase the button.

Displays

<Feature name> SHOW OK	The name of the feature assigned to a button is displayed when you press the button. SHOW appears when there is more information available. Press # or SHOW for additional information.
Enter code:	If you are checking a speed dial button, enter the two-digit speed dial code that you want to check.
F_ QUIT CLEAR	Enter the feature code, or press Rls or QUIT to quit programming or CLEAR to clear the numbers you have entered. The system accepts the entry as soon as you enter a valid feature code.
Feature code: QUIT	Press <input type="text" value="Feature"/> and enter the feature code you want to assign to the button. You cannot enter invalid codes.
Feature moved	You have programmed a button with a feature that was already programmed onto another button. The feature has moved to the button you just programmed. Its original button is now blank.
Press a button EXIT	Press the button you want to check. Press <input type="text" value="Feature"/> or EXIT when you are finished.
Program and HOLD	Enter the number you want to program and press <input type="text" value="Hold"/> . To erase the button, just press <input type="text" value="Hold"/> .
Program and OK QUIT OK	Enter the number you want to program and press OK . To erase the button, just press <input type="text" value="Hold"/> or OK .

For other displays, see [Common feature displays](#) on page 125.

Applying button cap labels

Before you apply button labels, activate the Button Inquiry feature (* 0) to verify the button functions, and to avoid activating features as you put the labels onto the buttons. For more information refer to [Finding out what a button does using Button Inquiry](#) on page 73.



Tip

Keep the extra labels and button caps with each Enterprise Edge telephone.

Types of button caps

- **Unlabeled, clear button caps**
with appropriate green or grey paper for typing in line numbers, telephone numbers, and features
- **Pre-printed, colored button caps**
in green or grey

Some examples of pre-printed button caps

Green caps	Grey caps
<input type="text" value="Line"/>	<input type="text" value="Last No."/>
<input type="text" value="Handsfree Mute"/>	<input type="text" value="Speed Dial"/>



Tip

To make identification of line types easier, use preprinted green button caps for lines that support incoming and outgoing calls. Use clear button caps for target lines that are incoming only.

Identifying the telephones

1. Write the individual telephone numbers on the labels and attach them to the appropriate Enterprise Edge telephones.
2. Write the telephone number and the internal number on the appropriate receiver card for each type and color of telephone that is to be installed.
3. Cover the receiver card underneath the receiver of each telephone with the plastic lens.

Enterprise Edge default button assignments

During Startup, the Enterprise Edge installer chooses one of the available templates. Default features are assigned automatically to the programmable buttons on Enterprise Edge telephones, and vary with the template and the telephone. The default features are listed in the following tables in this chapter.



Tips

Enterprise Edge telephones are shipped from the factory with the button caps in place for the PBX template.

Please consult your customer service representative to determine the type of template programmed into your system before applying button assignments.

Rules of default button assignment

Line and Intercom buttons are assigned by default templates and can be changed in programming. Handsfree/Mute and answer buttons are not assigned by default. If these features are defined, however, they are automatically assigned to specific buttons, as described on this and the following page. None of these buttons can be assigned to M7100 telephones.

The Handsfree/Mute feature appears on the bottom right-hand button, moving the Intercom button(s) up one position.

Each telephone can have up to eight Intercom buttons. They appear above the Handsfree/Mute button at the bottom right-hand position on your telephone.

Each telephone can have up to four answer buttons. They appear above Intercom buttons in the right column and continue up from the bottom in the left column, replacing the features on those buttons.

External line buttons appear in ascending line order, starting at the top button in the left column (the top button on the M7208 telephone). If more than five external lines are assigned to a M7310 telephone, or more than 12 to a M7324 telephone, assignment continues down the buttons on the right column, erasing the features on those buttons. Line buttons have priority over feature access buttons but not Handsfree/Mute, Intercom, or answer buttons.

M7310 and M7208 telephone button defaults

The default button assignments for the M7310 and M7208 telephones depend on the template applied. The exception is the default numbering for the dual memory buttons. Refer to [Understanding the telephone buttons](#) on page 12.

Dual memory buttons example

Set 233	...
Set 221	Set 227
Set 234	...
Set 222	Set 228
Set 235	...
Set 223	Set 229
Set 236	...
Set 224	Set 230

This example shows defaults for a system with three-digit internal numbers. The defaults do not actually exist on any telephone, as no telephone has an autodial button for itself. The position that would be taken by the autodial button for itself, is blank.

M7310 template button assignments

PBX	DID
DND	Line
Transfer	Transfer
Call Fwd.	Call Fwd.
Pick-Up	Pick-Up
Page	Page
Conf/Trans	Conf/Trans
Last No.	Last No.
Voice Call	Voice Call
Intercom	Intercom
Intercom	Intercom

M7208 template button assignments

PBX	DID
Pick-Up	Line
Transfer	Transfer
Last No.	Last No.
Page	Page
Conf/Trans	Conf/Trans
Speed Dial	Speed Dial
Intercom	Intercom
Intercom	Intercom

M7324 telephone button defaults

The default button assignments for the M7324 telephone depend on the template applied. Refer to [Understanding the telephone buttons](#) on page 12.

PBX			DID		
<input type="text"/>	Call Fwd.	Conf/Trans	<input type="text"/>	Call Fwd.	Conf/Trans
<input type="text"/>	Speed Dial	Transfer	<input type="text"/>	Speed Dial	Transfer
<input type="text"/>	Last No.	DND	<input type="text"/>	Last No.	DND
<input type="text"/>	Saved No.	Pick-Up	<input type="text"/>	Saved No.	Pick-Up
<input type="text"/>	<input type="text"/>	Voice Call	<input type="text"/>	Transfer	Voice Call
<input type="text"/>	<input type="text"/>	Page	<input type="text"/>	Line	Page
<input type="text"/>	<input type="text"/>	Intercom	<input type="text"/>	<input type="text"/>	Intercom
<input type="text"/>	<input type="text"/>	Intercom	<input type="text"/>	<input type="text"/>	Intercom

M7100 telephone button defaults

For all templates, the one programmable button on the M7100 telephone is Last No. .



Tip

The default Page button activates the External Page option (Feature 6 2).

Moving line buttons

Feature * 8 1

You can move external lines to different buttons on your telephone to arrange your lines in the way that makes the most sense to you.

You cannot move intercom, answer or Handsfree/Mute buttons onto a CAP module.

1. Press Feature * 8 1.
2. Press the line button you want to move.
3. Press the button to which you want to move the line.
4. Press Rls .

Displays

Exchanged	The two buttons you selected have exchanged position.
Invalid location	You have tried to move a line to a button that cannot be used as a line button, such as an intercom button, Handsfree/Mute button, or an answer button.
Move line from: QUIT	Press the button of the line you want to move. Press <input type="text" value="Feature"/> or <u>QUIT</u> when you have finished moving lines.
Move line to: QUIT	Press the button you want to move the line to. Neither of the buttons is erased. The lines, or the line and feature, simply switch places.
Press a line	The button you are trying to move is not a line button. If you are trying to switch a line and a feature, move the line to the feature button and not the feature button to the line.

Changing the type of ring

* 6

You can choose one of four distinctive rings for your telephone. This makes it easier to identify your telephone in an open office.

1. Press * 6.
2. Press , , , , or NEXT. You hear the selected ring for two seconds.
3. Repeat until you hear the ring you prefer, then press or OK.

Adjusting the Ring volume

* 8 0

1. Press * 8 0. The telephone rings.
2. Press to adjust the volume; left end for lower and right end for higher.

Hiding the message or calls indication

Feature 8 0 6

The display that shows you have messages or calls can be replaced with the current time and date. You can retrieve your message and call information by using the display buttons that appear on the second line of the display.

If you are using a telephone with a single-line display, the message or call indication is hidden.

1. Press Feature 8 0 6. The current time and date appears on the top line of the display.
2. Press **MSG** or Feature 6 5 to see your messages, or press **CALLS** or Feature 8 1 2 to see your calls.

Restoring the messages and calls indication

Press Feature # 8 0 6.

The Hunt Groups feature allows a group of Enterprise Edge sets to be called by a single directory number ensuring that calls are easily routed to the appropriate group.

Hunt Groups are used in situations where a group of people performing the same task are required to answer a number of related phone queries. Some typical uses of Hunt Groups are:

- a sales department answering questions on product prices or availability
- a support department answering questions concerning the operation of a product
- an emergency department answering calls for help.

Hunt Groups can be used to route calls to a support service such as a Help Line for a software company. Specialists dealing with Product A can be in one group, and specialists dealing with Product B can be in another group. Incoming calls hunt for the next available set in the group. If no set is available, the call can be placed in a queue or routed to an overflow set.

You need to start a Unified Manager session to program this feature. For more information about programming using the Unified Manager, see the *Enterprise Edge Programming Operations Guide*.

Programming changes can be made to the following Hunt Group settings:

- members of a group and member position in a group
- what lines are assigned to a group
- how incoming calls are distributed
- how long the system looks for available members
- where a call goes if all members are busy

Features affected by Hunt Groups include:

- Call Forward All Calls
- Call Forward No Answer
- Call Forward on Busy
- Group Pickup
- Transfer via Hold
- Priority Call
- Line Redirection
- Page Zones
- Voice Call

Members of the group

Members of the group can be any Enterprise Edge set, or portable. An Enterprise Edge set can be in more than one Hunt Group but is considered a member in each Hunt Group, increasing the total number of members in the system.

There can be only one appearance of the same Hunt Group on a set. Hunt Group DNs cannot be members of other Hunt Groups. A DN can be associated with a member of a Hunt Group and is called a member DN.

Distribution mode

There are three modes of call distribution:

- **Broadcast**—rings each set in the group simultaneously. Calls are handled one at a time; other calls are queued. As soon as a call is picked up, the call next in the queue is presented to the Hunt Group without having to wait for queue time-out.
- In Broadcast mode, a single incoming call rings simultaneously at all the sets in a group. This way, all receptionists in the group can share the load of answering large volumes of calls. All sets automatically display the calling line identification (CLID), if available. A familiar example is a fund-raising campaign where a group of operators are waiting to take each call as it comes in.
- **Linear**—starts the call at the first set in the Hunt Group and distribution is complete when the first free set has been found. Simultaneous calls can be presented. Distribution is order based.
- In Linear mode, you can program your top salesperson to be the first member of the group to receive incoming calls.
- **Rotary**—the call starts at the set after the one which answered the last call. Distribution is complete when the next free set has been found. Simultaneous calls can be presented. Distribution is order based.
- In Rotary mode, you can ensure that all your helpline people are receiving calls on an equal basis, rather than one person receiving the majority of calls. The call rings at one set at a time in a round robin fashion.

If a Hunt Group has available members but nobody answers the call, the call is routed through the Hunt Group list until either someone answers the call or the queue time-out occurs. In the latter case, the call is routed to the overflow position. Once a call goes to the overflow position it is no longer a Hunt Group call.

For information about Hunt Groups and software packaging, see the *Enterprise Edge Programming Operations Guide*.

Installing Enterprise Edge telephones

If you are connecting an Enterprise Edge telephone for the first time, refer to the following illustrations as a guide.

Installing an Enterprise Edge telephone

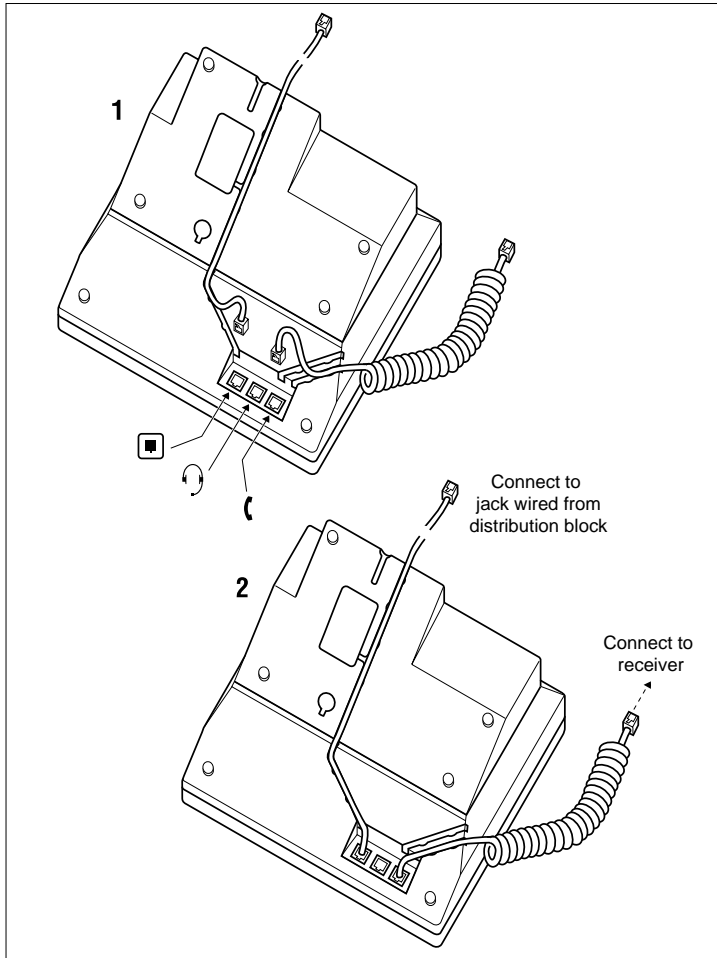

Mounting an Enterprise Edge telephone on the wall

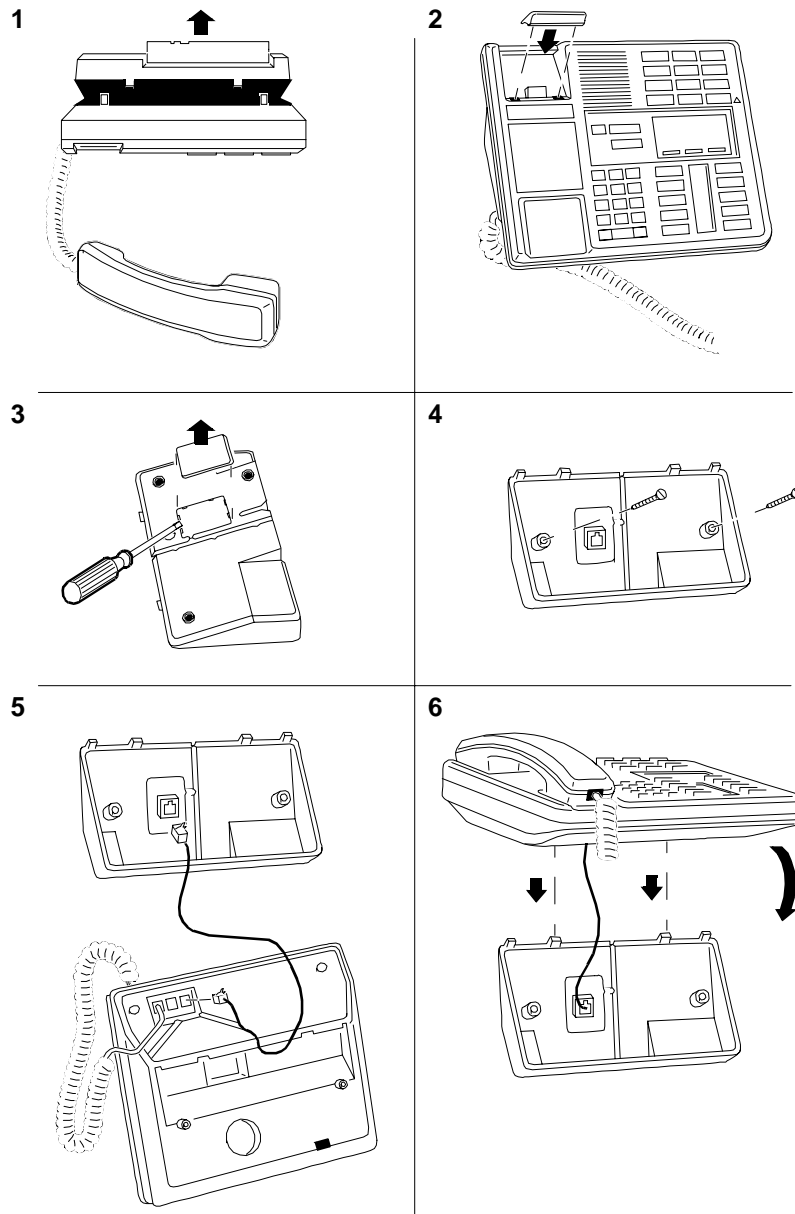

Naming a telephone or a line

You can assign names to identify external lines, target lines, and your co-workers' telephones. During a call, the name (if programmed) is shown on the telephone display instead of the external line number or internal telephone number of the caller. You need to start a Unified Manager session to program this feature. For more information about programming using the Unified Manager, see the *Enterprise Edge Programming Operations Guide*.

Telephone names and line names can contain both letters and numbers, but cannot be longer than seven characters. You cannot use the # and * symbols.

**Tip**

You can give the same name to two or more telephones, or to a telephone and a line in your system. To avoid confusion, avoid such duplication. Use initials, abbreviations, or even nicknames to give each telephone a unique name.

If automatic telephone relocation is turned on, the name and internal number of a telephone are saved if the telephone is moved within your system.

Moving telephones



You may be required by law to report any telephone moves to your local telecommunications carrier or 911 service provider. For further details, consult your local carrier, your local 911 service provider, and/or your local telecommunications service provider.

If automatic telephone relocation is enabled in programming by your installer, you can move your telephone from one Enterprise Edge jack to another without losing any of its custom programming.

Stopping calls from ringing at your telephone using Do Not Disturb (DND)

Feature 8 5

Stopping calls

Press Feature 8 5 to stop calls from ringing at your telephone.

Only priority calls ring at your telephone. A line button flashes when you receive a call, but the call does not ring.

Refusing to answer a call

While you are on a call, you can refuse to answer a second call (including a priority call).

Press Feature 8 5 while your telephone is ringing.

Canceling Do Not Disturb

Feature # 8 5

Press Feature # 8 5.

Displays

Allow calls Your telephone receives calls normally.

Using Do Not Disturb

Once you turn Do Not Disturb on, calls are forwarded to the prime telephone only if there is no other telephone on which the line appears. If there is another telephone that shares the same line, the call may be answered by that person. (The Delayed Ring Transfer feature transfers all unanswered calls to the prime telephone after a specified time.)

Do Not Disturb prevents voice calls from alerting at your telephone. Voice calls are presented as normal intercom calls.



Tip

Enterprise Edge sets that are members of a Hunt Group can temporarily leave a Hunt Group by activating this feature. Hunt Group calls arriving while a set is in Do Not Disturb mode are routed to the next member in the Hunt Group. For more information on Hunt Groups see [Hunt Groups](#) on page 83.

Using Background Music

Feature 8 6

Listen to music through your telephone speaker by pressing 8 6 .

Your installer makes this feature available to all telephones in programming. You need to supply a music source, such as a radio, and have it attached to your Enterprise Edge system.



In accordance with U.S. copyright law, a license may be required from the American Society of Composers, Authors and Publishers or a similar organization if radio or TV broadcasts are transmitted through the Background Music feature of this telecommunication system. Northern Telecom Inc. hereby disclaims any liability arising out of the failure to obtain such a license.

Turning Background Music off

The music stops automatically if you make or answer a call or if you press

Feature # 8 6 .

Integrated Services Digital Network (ISDN) technology provides a fast, accurate and reliable means of sending and receiving data, image text and voice information through the telephone system.

Using ISDN Primary Rate Interface (PRI) allows for faster transmission speeds and the addition of a variety of powerful business applications, including remote LAN access, videoconferencing, file transfer, and Internet access.

Your installer configures your ISDN services and terminal equipment.

Benefits

PRI is economical because separate analog trunks and data circuits are not needed for Direct Inward Dialing (DID), Direct Outward Dialing (DOD) and data transfer.

With PRI there is greater flexibility because B channels can be dynamically reconfigured to accommodate changes in traffic with the Call by Call feature. For more information see [Call by Call service selection for PRI](#) on page 91.

PRI offers fast information access because channel usage is optimized to allow you the full benefit of available bandwidth and real-time connectivity.

PRI lines are configured as DID lines. Incoming calls on a PRI line can appear on a DID button or on an intercom button depending on how your Enterprise Edge set has been configured. Outgoing calls are made from the intercom buttons.

PRI lines can be accessed from all devices such as Enterprise Edge sets and wireless sets.

ISDN PRI features

Selected ISDN network features can be used from an Enterprise Edge telephone. Your central office switch (ISDN network) determines which features are available to you.

Network Name Display for PRI

Your Enterprise Edge system displays the name of an incoming call when it is available from the service provider. Name information can be displayed on an Enterprise Edge set. If the Calling Party Name has the status of “private” it may be displayed as “Private name”. If the Calling Party Name is unavailable it may be displayed as “Unknown name”.

Your Enterprise Edge system displays the name of the called party on an outgoing call, when it is provided by your service provider.

Your Enterprise Edge system sends the Business Name concatenated with the set name on an outgoing call but only after the Business Name has been programmed.

The available features include:

- Receiving Connected Name
- Receiving Calling Name
- Receiving Redirected Name
- Sending Connected Name
- Sending Calling Party Name

Consult your customer service representative to determine which of these features is compatible with your service provider.

Name and number blocking for PRI

When activated, Feature 8 1 9 allows you to block the outgoing name and/or number on a per-call basis. Name and number blocking can be used with an Enterprise Edge set.

Consult your customer service representative to determine whether or not this feature is compatible with your provider.

Emergency 911 Dialing

Enterprise Edge with the ISDN PRI feature is capable of transmitting the telephone number and internal extension number of a calling station dialing 911 to the Public Switched Telephone Network. State and local requirements for support of Emergency 911 Dialing service by Customer Premises Equipment vary. Consult your local telecommunications service provider regarding compliance with applicable laws and regulations.

If transmission of internal extension numbers is not required or desired, then it is recommended that you maintain a site map or location directory that allows emergency personnel to rapidly locate an Enterprise Edge set given its DID number. This list should be kept up to date and readily available, and can be included in the Programming Record.

2-way DID

With PRI the same lines can be used for receiving direct inward dialing (DID) and for making direct outward dialing (DOD) calls.

The dialing plan configured by your customer service representative determines how calls are routed.

Consult your customer service representative to determine whether or not this feature is compatible with your service provider.

Call by Call service selection for PRI

PRI lines can be dynamically allocated to different service types with the Call by Call feature. PRI lines do not have to be pre-allocated to a given service type.

Call types that may be available, depending on your service provider are:

Public

Public calls connect your Enterprise Edge set with a Central Office (CO). DID and DOD calls are supported.

Private

Private calls connect your Enterprise Edge set with a Virtual Private Network. DID and DOD calls are supported. A private dialing plan may be used.

Tie

Tie lines are private incoming and outgoing lines that connect Private Branch Exchanges (PBX) such as Enterprise Edge.

FX (Foreign Exchange)

FX calls connect your Enterprise Edge set to a remote CO. It provides the equivalent of local service at the distant exchange.

Outwats

Outwats is for outgoing calls. This allows you to originate calls to telephones in a specific geographical area called a zone or band. Typically a flat monthly fee is charged for this service.

Inwats

Inwats is a type of long distance service which allows you to receive calls originating within specified areas without a charge to the caller. A toll-free number is assigned to allow for reversed billing.

Consult your customer service representative to determine whether or not this feature is compatible with your provider.

Dialing Plan and PRI

The Dialing Plan supports PRI connectivity to public and private networks. The dialing plan is a collection of features responsible for processing and routing incoming and outgoing calls. All PRI calls must go through a dialing plan.

The Dialing Plan

- allows incoming calls to be routed to sets based on service type and digits received
- allows Enbloc dialing by buffering user-dialed digits until a complete DN has been dialed
- provides the ability to map user-dialed digits to a service type on a Call by Call basis

- allows long distance carrier selection via user-dialed Carrier Access Codes

Consult your customer service representative to determine how your dialing plan is configured.

Service provider features

Consult your customer service representative to determine if the new ISDN features are supported with your service provider.

Call Forward

Call Forward allows you to forward your calls to an external telephone number.

1. Select an ISDN line by selecting a line button, a line pool, or the Handsfree button, or by lifting the handset (if an ISDN line is your prime line).
2. Consult your service provider for the appropriate feature code to enter on your dial pad. Listen for three tones followed by dial tone.
3. Enter the internal number of the telephone to which you want your calls forwarded. If the call is answered, stay on the line for at least five seconds to activate the Call Forward feature.

Canceling Call Forward

1. Select an ISDN line by selecting a line button, a line pool, or the Handsfree button, or by lifting the handset (if an ISDN line is your prime line).
2. Consult your service provider for the appropriate feature code to enter on your dial pad. Listen for a series of tones.
3. Press .

Calling the number your calls are forwarded to

1. Select an ISDN line by selecting a line button, a line pool, or the Handsfree button, or by lifting the handset (if an ISDN line is your prime line).
2. Consult your service provider for the appropriate feature code to enter on your dial pad.

Automatic Call Back

If you call a number and it is busy, enter the appropriate feature code designated by your service provider to receive a distinctive ring at your set when the line becomes available for calls.

Automatic Recall

Automatic Recall allows you to automatically dial the number of the last call you received. You may not see the number on the display if the information is not available from your service provider, or you do not have Caller ID as part of your ISDN service.

Consult your service provider for the appropriate feature code to enter on your dial pad.

ISDN applications for PRI

ISDN terminal equipment delivers a wide range of powerful business applications:

Videoconferencing and video telephony

Video conferencing offers instant visual and audio contact between distant parties using studio-based terminals.

Desktop conferencing

ISDN allows computer users in distant locations to share and edit any image, data or text file on their own computer screens while they discuss the information.

File transfer

The ISDN network allows you to transfer files containing data, text, images, data, or audio clips, faster and cheaper than with a conventional modem.

Telecommuting

Convenient retrieval, processing and storage of files is possible for the employee working at home by using ISDN lines to give high-speed access to information resources at the office.

Group 4 fax

ISDN fax applications save money by increasing both transmission speed and the quality of resolution.

Remote LAN access

ISDN provides an affordable and fast means for employees at remote sites (at home or branch offices) to access local area networks (LANs).

Leased line backup

Essential backup for leased lines can be provided using ISDN as required, rather than duplicating costly permanent leased lines.

LAN to LAN bridging

Local area network (LAN) bridge/routers allow flexible interconnection between LANs using ISDN, with charges incurred only when information is actually transmitted.

Internet and database access

The fast call set up and high bandwidth of ISDN are ideal for accessing information services such as the Internet and databases.

Using alternate or scheduled services

There are three types of Services to make your Enterprise Edge system handle calls differently on different days and at different times of the day: Ringing service, Restriction service and Routing service.

Each of the three services, and the six schedules available to each service, are customized for you by your installer who programs one telephone which is used to turn Services on and off, and display what Services are in use. This is called the control telephone.

Preventing certain calls from being made

Restriction service prevents a user from making certain kinds of calls from a telephone or from lines that are available at the telephone. The restrictions are programmed by your installer.

Making additional telephones ring

Ringing service makes additional telephones ring for incoming calls on external lines. For instance, all incoming external calls can ring at a security guard's telephone during the night, or calls to one attendant can ring at another attendant's telephone during lunch. It does not suppress your normal ringing assignment.

Changing the lines used by outgoing calls

Routing service allows you to assign alternate routes to calls. In this way you can take advantage of lower costs available on particular routes on certain days and at certain times. Both the regular and alternate routes are programmed by your installer.

Turning Services on and off

Three programming settings: Manual, Automatic and Off, control how different services and their schedules are used by your system.

- Manual allows you to turn the service on and off at any time from a control telephone using a feature code.
- Automatic allows you to use the preassigned stop and start time for a service. You are able to start and stop the service by entering the appropriate feature code at a control telephone. If you select this setting, you use the start and stop times programmed by your installer.
- Off prevents the service from being activated.

For more information about programming using the Unified Manager, see the *Enterprise Edge Programming Operations Guide*.

Each schedule can have its own configuration of a Service which works independently of automatic start and stop times. For example, there may be a version of Restriction service called Night Schedule that prevents anyone from making long distance calls. But calling it Night Schedule does not mean it can only be used with a schedule. You can turn the Night Schedule for Restriction Service on or off as needed any time of the day or night. If you decide to run a service on a schedule, the system uses the start and stop times used for that schedule.

Turning Services on and off using feature codes

The master control for services is accessed from the Unified Manager. Day-to-day use of Services is controlled using the following feature codes.

Feature	8	7	1	Turns on Ringing service. When used at the direct-dial telephone, it activates the alternate direct-dial telephone (extra-dial telephone).	
Feature	#	8	7	1	Turns off Ringing service.
Feature	8	7	2	Turns on Restriction service.	
Feature	#	8	7	2	Turns off Restriction service.
Feature	8	7	3	Turns on Routing service.	
Feature	#	8	7	3	Turns off Routing service.

To turn a Service on:

1. Enter the appropriate feature code from a control telephone.
2. Press **NEXT** to move through the schedules until the display shows the version of the service you want to be turned on.
3. Press **OK** to select the setting, or press **QUIT** to exit the feature without making any changes.

To turn a Service off:

1. Enter the appropriate feature code from a control telephone.



Do not confuse activating Normal service with canceling a Service.

Setting a Service to Normal is not the same as canceling a Service using a feature code. If you set the Service to Normal, the normal version of a Service overrides any automatic schedule and remains in effect until you manually cancel it. If you cancel the Service, you return to the automatic schedule.

Viewing the active Services from a two-line display telephone

When a Service is active, the control telephone display reads **Services ON**.

1. Press **LIST**. The display shows the first active Service and the schedule that is in use.

2. If there are several active Services, press **NEXT** to see them all.
3. Press **EXIT** to exit the feature.

Viewing the active Services from a one-line display telephone

1. Press **Feature** . The display shows the first active Service.
2. Press **#** to move through the active schedule.
3. Press **Rls** to exit.

Displays

<Sched> Restr'n EXIT NEXT	You are viewing the active Services. Press # or NEXT to see the other active Services. Press Rls or EXIT to quit.
<Sched> Restr'n QUIT OK NEXT	The name of the current Restriction service schedule is displayed. Press # or NEXT to see the other Ringing service schedules. Press Hold <input type="text" value=""/> or OK to select the desired schedule.
<Sched> Ringing EXIT NEXT	You are viewing the active Services. Press # or NEXT to see the other active Services. Press Rls or EXIT to quit.
<Sched> Ringing QUIT OK NEXT	The name of the current Ringing service schedule is displayed. Press # or NEXT to see the other Ringing service schedules. Press Hold <input type="text" value=""/> or OK to select the desired schedule.
<Sched> Routing EXIT NEXT	You are viewing the active Services. Press # or NEXT to see the other active Services. Press Rls or EXIT to quit.
<Sched> Routing QUIT OK NEXT	The name of the current Routing service schedule is displayed. Press # or NEXT to see the other Routing service schedules. Press Hold <input type="text" value=""/> or OK to select the desired schedule.
<Sched> until * QUIT OK NEXT	Press Hold <input type="text" value=""/> or OK to select this schedule, # or NEXT to see the next available schedule, or Rls or QUIT to exit. If you select this schedule, it is in effect until the next automatic schedule takes effect.
No services ON	You have entered the Show Services feature code and there is no active Service.
Services ON LIST	There is a Service active in your system. Press * or LIST to view the active Services.

For other displays, see [Common feature displays](#) on page 125.

Services that have been turned on automatically are indicated by an asterisk (*) before the name on the display. You can neither manually activate nor cancel scheduled services, although you can override them by manually turning on another schedule.

The control telephone can override Services that are turned on and off according to a schedule at any time by entering a Services feature code, and selecting a different schedule. This override remains in effect until it is canceled. If you select a schedule with an asterisk (*), the next automatic service schedule comes into effect at the programmed time.

Direct-dial calls to a direct-dial telephone ring at the extra-dial telephone (the extra-dial telephone is designated by your installer) only when you enter the Ringing service feature code (Feature) at that direct-dial telephone. Note that only the extra-dial telephone is activated, not the actual Ringing service (unless that direct-dial telephone is a control telephone).

**Tip**

Enterprise Edge provides six service schedules named Night, Lunch, Evening, Sched 4, Sched 5, and Sched 6. Your installer can change these names to suit your business.

User passwords

User passwords prevent unauthorized or unintentional changes to your Enterprise Edge system. There are two types of user password: Registration and Call Log.

Registration password

The Registration password is used to control the registration of Companion portables to the Enterprise Edge system. For more information see the *Enterprise Edge Programming Operations Guide*.

Clearing a Call Log password

If an individual has forgotten their Call Log password, you can clear it in programming. The individual can then enter a new password from his or her telephone.

You need to start a Unified Manager session to program this feature. For more information about programming using the Unified Manager, see the *Enterprise Edge Programming Operations Guide*.

Using special telephones

Direct-dial

You can reach the direct-dial telephone by dialing a single digit. The direct-dial telephone is usually in a central location, such as a attendant's desk. You can have up to five direct-dial telephones for your Enterprise Edge system. It is usually the prime telephone or the central answering position (CAP).

The direct-dial telephone can send up to 30 messages and can invoke Services to activate the extra-dial telephone.

You cannot forward calls to a direct-dial telephone that is outside your Enterprise Edge system.

Changing the direct-dial telephone assignments

Your installer sets up the direct-dial telephone.

You can change which direct-dial telephone a telephone is assigned to, or assign it no direct-dial telephone. You need to start a Unified Manager session to program this feature. For more information about programming using the Unified Manager, see the *Enterprise Edge Programming Operations Guide*.

Any number of telephones can be assigned to call the direct-dial telephone.



Tip

The digit you dial in order to get the direct-dial telephone to ring can be programmed by your installer.

The Enterprise Edge system cannot verify that the number you assign as an external direct-dial telephone is valid. Check the number before assigning it as a direct-dial telephone, and call the direct-dial telephone after you've assigned it in order to test it.

Hotline

A hotline telephone calls a preset internal or external telephone number when you pick up the receiver (or press ).



Tip

Label the telephone to inform anyone using it that Hotline is active.

Bypassing a Hotline

Press a line button, or use the Pre-Dial or Automatic Dial feature before you pick up the receiver or press  on a hotline telephone. See the **Telephone Feature Card** or see [Changing how you dial your calls](#) on page 34.

Making a telephone a hotline telephone

You can set up a telephone as a hotline.



Tip

A Hunt Group set DN can be specified as a Hotline telephone. For more information on Hunt Groups see [Hunt Groups](#) on page 83.

You need to start a Unified Manager session to program this feature. For more information about programming using the Unified Manager, see the *Enterprise Edge Programming Operations Guide*.

Internal assigns an internal number. External assigns an external number. If you select an external number, you can select the line on which the call is made: the prime line, an external line, a line in a line pool, or a line selected by the routing table. If you select a line pool, you must specify the line pool access code. If you select the routing table, the number dialed is treated as a destination code and is routed according to the routing tables.

A telephone's prime line, line pool access codes, and access to a line pool can be programmed by your installer.

Control telephone

The control telephone allows you to place the telephones and external lines for which it has responsibility into and out of service schedules. See [Using alternate or scheduled services](#) on page 95.

Using Set lock

Set lock limits the ways in which you can customize your telephone. There are three levels of Set Lock: Full, Partial, and None. None allows you to access all features on your telephone.

Partial prevents:

• programming autodial buttons	• changing dialing modes (Automatic Dial, Pre-Dial, and Standard Dial)
• programming user speed dial numbers	• using Voice Call Deny
• programming feature buttons	• saving a number with Saved Number Redial
• moving line buttons	
• changing the display language	

Full, in addition to the restrictions outlined for Partial lock, prevents:

• changing Background Music	• using Call Forward all calls
• changing Privacy	• using Send Message
• changing Do Not Disturb	• using Trunk Answer
• using Ring Again	• activating Services

Changing Set Lock programming for a telephone

You need to start a Unified Manager session to program this feature. For more information about programming using the Unified Manager, see the *Enterprise Edge Programming Operations Guide*.

Using an auxiliary ringer

An auxiliary ringer is a separate device that has to be connected to Enterprise Edge.

Turning the auxiliary ringer for a telephone on or off

You need to start a Unified Manager session to program this feature. For more information about programming using the Unified Manager, see the *Enterprise Edge Programming Operations Guide*.

Your installer can program the auxiliary ringer to start ringing for incoming lines as part of Ringing Service.

Using Host System dialing signals

You can access host systems, such as private branch exchanges (PBX) from Enterprise Edge by using host system signaling features (known as end-to-end signaling). These features either send a special signal to the host system or allow you to program delays required by host systems in external autodial or speed dial sequences.

Link

Feature

If your Enterprise Edge system is connected to a private branch exchange (PBX), you can use a Link signal to access special features. On some telephones, Link is called FLASH.

The Link signal can be included as part of a longer stored sequence on an external autodial button or in a speed dial code. The Link symbol (☒) uses two of the 24 spaces in a dialing sequence.

Preventing a telephone from using Link

Link can be restricted at individual telephones. You need to start a Unified Manager session to program this feature. For more information about programming using the Unified Manager, see the *Enterprise Edge Programming Operations Guide*.



Tip

If your Enterprise Edge system is connected to a private branch exchange (PBX), program Link onto a memory button for one-touch access.

Pause

Feature

The Pause feature enters a 1.5 second delay in a dialing sequence on an external line. This is often required for signaling remote devices, such as answering machines, or when reaching through to PBX features or host systems.

You can program more than one pause in an external autodial or speed dial sequence.

The Pause symbol (Ⓟ) uses one of the 24 spaces in a dialing sequence.

For pulse dialing, inserts a 1.5 second pause into the dialing sequence.

Long Tones

Feature

The Long Tones feature allows you to control the length of a tone so that you can signal devices such as fax or answering machines which require tones longer than the standard 120 milliseconds.

1. While on a call, press .
2. Press the dial pad buttons to produce the appropriate tones. Each tone sounds for as long as you hold down the button.

Long tones can be used on any call except a conference call. You can use internal lines of the Enterprise Edge system to activate a device connected to an Enterprise Edge ATA2 or an ASM in another area of your office, or external lines to access devices outside the Enterprise Edge system.

Displays

Long Tones: At the appropriate time, press any dial pad button. Hold each button down for as long as necessary. Press or to cancel Long Tones.

Programmed Release

Feature

The Programmed Release feature performs same function as in a programmed dialing sequence. When the system encounters Programmed Release in a dialing sequence, it stops dialing and hangs up the call.

The Programmed Release symbol (Ⓡ) takes up two of the 24 spaces in a programmed dialing sequence.

The system ignores any digits or commands that follow a Programmed Release in a programmed dialing sequence.

Run/Stop

Feature * 9

Run/Stop inserts a break point into a sequence of dialed numbers or characters used for automatic dialing. This may be necessary when you are connecting to a PBX or similar host system.

For example, you can call a company with an automated attendant that instructs you to dial the internal number you need. You can program the company number, a Run/Stop, then the internal number on one external autodial button. Press the autodial button once to dial the company number. When you hear the automated attendant, press the autodial button again to dial the internal number.

The Run/Stop symbol (■) uses one of the 24 spaces in an autodial or speed dial sequence.

You can include up to three Run/Stop commands in a dialing string. The system ignores a fourth Run/Stop, and any digits or commands that follow it in a programmed dialing sequence.

Wait for Dial Tone

Feature 8 0 4

Wait for Dial Tone causes a sequence of numbers to pause until dial tone is present on the line before continuing to dial. This is useful if you must dial a remote system and then wait for dial tone from that system before dialing the rest of your number.

The Wait for Dial Tone symbol (■) uses two of the 24 spaces in an autodial or speed dial sequence.

Displays

Invalid code

You have entered a code that can be used only in a programmed autodial or speed dial sequence, not on a call you dial directly. Programmed Release and Run/Stop are for use in programmed dialing sequences only.

Using pulse dialing for a call

If your external telephone lines use pulse dialing, you can temporarily switch to tone dialing by pressing # after selecting the line. Tone dialing allows your Enterprise Edge telephone communicate with devices and services that respond to tone signals, such as automatic switchboards, and fax or answering machines.

Using your Enterprise Edge system from an external location

You can use the lines and some of the features of an Enterprise Edge system from outside the system. You can do this over the public telephone network when you are away from the office, or you can call from another system, over a private network.

An example of how remote access works is a sales representative who spends a lot of time out of the office needs to make long distance calls to the European office. Your Enterprise Edge system has a leased line to Europe with reduced transatlantic charges. You provide the sales representative with a Class of Service password that gives access to the transatlantic line. The sales representative can then telephone into the Enterprise Edge system from a hotel, enter their Class of Service password, and use the leased transatlantic line to make calls.

Remote users can access Enterprise Edge lines, line pools, the page feature, and remote administration (if enabled through Software Keys). The exact facilities available to you through remote access vary depending on how your installer set up your system.



Tip

If the loop start line used for remote access is not supervised, auto-answer does not function and the caller hears ringing instead of a stuttered tone or the system dial tone.

Controlling access to your Enterprise Edge system

It is important to maintain the security of your Enterprise Edge system by limiting access to authorized users and limiting those users to the features they need.



Remote users can make long distance calls.

Remember that a remote user can make long distance calls that are charged to your company and can make page announcements in your office.

Direct inward system access (DISA)

Control access to your Enterprise Edge system with direct inward system access (DISA). Access to your Enterprise Edge system from the public telephone network should always be controlled with DISA. If your installer programs the line used for remote access to answer a call automatically and wait for a DISA internal number, callers hear a stuttered dial tone and must enter a Class of Service password before they are allowed into the system.

Class of Service (COS)

To control the level of telephone service a remote user can access, your installer can assign a remote filter and remote package to the line used for remote access. The remote filter restricts the numbers that can be dialed on the line, and the remote package restricts the use of line pools and the page feature. To change the restrictions for the line, the user can enter their Class of Service (COS) password when the system answers with DISA, or can dial the DISA internal number and enter their Class of Service password.

Maintaining security

To maintain the security of your system, the following practices are recommended:

- Warn anyone to whom you give the remote access number, to keep it confidential.
- Change Class of Service passwords often.
- Warn anyone to whom you give a Class of Service password, to remember it and not to write it down.
- Remove the Class of Service password of anyone who leaves your company.

Accessing Enterprise Edge remotely over the public network

1. Dial the Enterprise Edge system's remote access number.
2. When you hear a stuttered dial tone, enter your COS password.
3. Wait for the system dial tone.

To use the system remotely, you must use a telephone with tone dialing to call the system. Remote access is possible only on lines that your installer programs to auto-answer calls.

To use features on a remote Enterprise Edge system, press followed by the feature code. Even if you are calling from an Enterprise Edge system, press instead of .

In certain situations, you may experience lower volume levels when using Enterprise Edge remotely.

Tones

You may hear some of the following tones while accessing Enterprise Edge remotely.

Tone	What it means
Busy tone	Dialed a busy line pool access code. You hear system dial tone again after 5 seconds.
Enterprise Edge system dial tone	You may use Enterprise Edge remotely.
Fast busy tone	You have done one of the following Entered an incorrect COS password. Your call is disconnected after five seconds. Taken too long while entering a COS password. Your call is disconnected after five seconds. Tried to use a line pool or feature not permitted by your Class of Service. You hear system dial tone again after five seconds. Dialed a number in the Enterprise Edge system which does not exist. Your call is disconnected after five seconds.
Stuttered dial tone	Enter your COS password.

Using Class of Service (COS) passwords

Class of Service passwords permit controlled access to a system's resources both by internal and remote users. When you enter a Class of Service password at a telephone, the restriction filters associated with your Class of Service password apply, rather than the normal restriction filters. Similarly, when a remote user enters a Class of Service password on an incoming auto-answer line, the restriction filters and remote package associated with their Class of Service password apply, rather than the normal restriction filters and remote package. COS passwords are programmed by your installer.

Users should memorize their COS passwords instead of writing them down. Employees' COS passwords should be deleted when they leave the company. Typically, each user has a separate password. Several users can share a password or one user can have several passwords.

Changing your Class of Service

Feature 6 8

You must enter a Class of Service password each time you want to make a call that is normally restricted on a line or telephone.

To change the restriction filters on a line or telephone:

1. Press 6 8.
2. Enter your six-digit COS password.

COS passwords allow you to define individual passwords and determine the restriction filters, and remote package associated with each.



Tip

If you use your Enterprise Edge system from outside the office, you may have to enter a Class of Service password to gain access to the system. See [Using your Enterprise Edge system from an external location](#) on page 103.

The following features are available for the entire Enterprise Edge system.

Pulse or tone dialing

If your external lines use pulse dialing, you can switch temporarily to tone dialing to communicate with devices such as answering machines, to access the features that PBX systems may offer, or to use another Enterprise Edge system remotely.

Press **#** while on an active line. Once you hang up, your telephone returns to pulse dialing.

Disconnect supervision

When Disconnect Supervision is assigned to a line, the Enterprise Edge system monitors it to detect if an external caller hangs up. This allows the system to release the line for other uses. Your installer assigns disconnect supervision.

Hunt Groups

Your Enterprise Edge system now allows you to establish Hunt Groups in your system. Hunt Groups are a group of Enterprise Edge sets that can be called by a single directory number. The Hunt Groups feature ensures calls are easily routed to the appropriate people. For more information on Hunt Groups see [Hunt Groups](#) on page 83.

Internal numbers

Each telephone in the Enterprise Edge system has its own internal number. The length of internal numbers in your system can be from two to seven digits on a non-expanded system, and three to seven digits on an expanded system. All numbers in your system are the same length. Your installer sets the length of internal numbers (called the DN length). The default DN length is three.

To find out your internal number, use the Button Inquiry feature (**Feature** ***** **0**) on an intercom button. On the M7100 telephone, Button Inquiry shows your internal number followed by the function assigned to your single-memory button.

Line assignment

Any of the lines in your system can be assigned to any of your telephones. Your installer assigns lines to telephones in Configuration programming. Lines can be assigned to appear only, appear and ring, or to ring only.

Usually, only the lines that are appropriate for a particular person appear at that person's telephone. When a line is assigned to a telephone it is automatically given a line button on that telephone, if a button is available. The M7100 telephone has no line buttons for its lines.

Calls on lines that ring but do not appear at a telephone are presented at an intercom button.

You may be able to answer a call on a line that does not appear or ring at your telephone. To pick up such a call, use Call Pickup, Call Park, or Trunk Answer.

A telephone may have buttons assigned for lines 001 to 003, but have only lines 001 and 002 programmed to ring as well. An incoming call on any of the three lines causes a line button indicator to flash, and the telephone can be used to answer the call. This is especially useful for people who monitor other telephone lines, but want only their own lines to ring.

Target line

A target line is used to route a call directly to a particular telephone or group of telephones. Target lines are used only for incoming calls. A single incoming line may provide connections to several different target lines. This allows each person or department in the office to have their own number without having a separate external line for each number.

Line pools

A line pool allows each telephone access to external lines from a group (or pool) of external lines. You can access such lines by pressing an intercom button and entering a line pool access code or by pressing a memory button programmed with the line pool feature code and a line pool access code.

Overflow call routing

If a call comes in for a target line that is busy, Enterprise Edge routes the call to the prime telephone for that target line. If there is no prime telephone assigned to the target line or if a call cannot be directed to a target line, the call goes to the prime telephone for the external line used.

Overflow routing for incoming calls is used with the Routing Service programmed by your installer. A Service must be active for overflow routing to be in effect. Overflow routing is not available in normal service.



Tips

When you make a call and the programmed route is busy, you hear the expensive route warning tone and see a display indicating that an expensive route is being used. To avoid using the normal, expensive route, release your call.

Because overflow routing directs calls using different line pools, a call may be affected by different line filters when it is handled by overflow routing.

M7100 telephone

Because the M7100 telephone does not have line buttons, it sometimes works slightly differently from other Enterprise Edge telephones. Where other telephones can require that you select a line button to answer a call, on the M7100 telephone you simply pick up the receiver. Where other telephones require you to select a line button to take a call off hold, you press on the M7100 telephone.

On M7100 telephones, you can answer a second call by pressing . Your active call is put on hold and you are connected to the waiting call. You can have no more than two calls at a time.

The M7100 telephone cannot have a button. When applicable, special instructions for the M7100 telephone are included with each feature description.

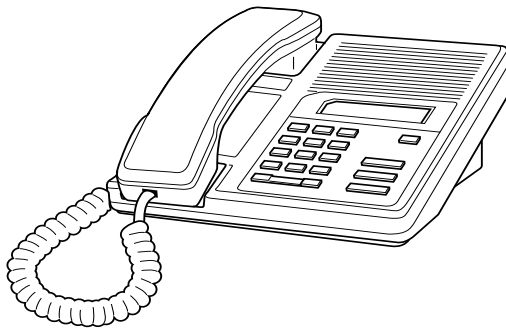

Memory buttons

Memory buttons are the buttons with indicators on the M7310, M7208, and M7324 telephones, and the dual buttons without indicators on the M7310 telephone. There is a single memory button, without an indicator, on the M7100 telephone. Memory buttons can be used as answer, autodial, line, and programmed feature buttons. Line, intercom and answer buttons must have indicators.









One-line display

The M7100 telephone has a one-line display. Other Enterprise Edge telephones have a second line on the display which shows the functions of the three buttons directly below it.

Some display buttons, such as TRANSFER and ALL, are simply shortcuts which are not available on a one-line display.

Other display buttons, such as OK and SHOW, perform essential functions. For a one-line display telephone, use the following buttons instead of these display buttons.

Substitutes for display buttons

Display button	Dial pad button
<u>OK</u>	Hold 
<u>QUIT</u>	Rls 
<u>ADD</u>	* 
<u>SHOW</u>	# 
<u>CANCEL</u>	# 
<u>VIEW</u>	# 
<u>OVERRIDE</u>	# 
<u>BKSP</u>	

All displays listed in this book are shown as they appear on the two-line display.

Prime line

Your telephone can be programmed to select an internal or external line or a line pool automatically whenever you lift the receiver or press . This is your prime line.

Private lines

A private line is exclusive to a particular telephone. Calls that are put on hold or left unanswered on a private line cannot be picked up at any telephone except the prime telephone.

Volume bar

The volume bar controls the volume of the receiver, telephone ringer, handsfree speaker, and headset. Press either end of the volume bar  to adjust the volume.

Wall mounting

Enterprise Edge telephones can be mounted on a wall. Contact the installer if you want to have any telephones in your system wall-mounted.

Hospitality Services (HS) is a group of features that increases the value of the Enterprise Edge system in small to medium sized facilities such as hotels, motels or hospitals.

In a hotel setting, guests gain improved services through immediate access to basic functions like:

- wake-up service or reminders
- accurate tracking of the room's service requirements.

Enterprise Edge telephones are classified as one of three types of sets: a common set, a room set or a Hospitality Services (HS) admin set.

Common set

A common set can be a telephone found in a lobby, office, or common area, it is not associated with a room. A common set does not have access to all of the HS features.

Common sets are Enterprise Edge telephones or analog telephones connected to an analog terminal adapter (ATA), or an analog station module (ASM).

Room set

A Room set is a set assigned to a room. You need to start a Unified Manager session to assign a Room set to a room. For more information about programming using the Unified Manager, see the *Enterprise Edge Programming Operations Guide*. Up to five sets can be assigned to the same room (they all share same room number).

Room sets can be any Enterprise Edge telephone or an analog telephone connected to an ATA or an ASM.

Hospitality Services (HS) admin set

A Hospitality Services (HS) admin set is any two-line display Enterprise Edge telephone. A HS admin set can be programmed (see the *Enterprise Edge Programming Operations Guide*) to require a user to enter the Desk admin password before access to HS admin features is granted.

Alarm time (AL) feature

The Alarm time feature provides an alarm clock capability on Enterprise Edge and analog telephones connected to an ATA or an ASM. Both room sets and common sets can be programmed to sound an audible alert at a requested time.

One Alarm time within a 24 hour period is programmable on a room or common set and must be reset daily. When the alarm sounds, all sets in a given room alert. Canceling the alarm on any set cancels the alarm on all the sets in the room. A new Alarm time entered on a room or common set overwrites any alarm set previously.

If the Enterprise Edge system experiences a power failure, the failure can result in missed Alarm times. When the Enterprise Edge system is running and the system's time resets, the missed Alarm times alert in respective room or common sets. At all times, the Enterprise Edge system allows up to a maximum of 25 sets that can alert at the same time.

Programming the Alarm time feature

To program the Alarm time feature on an Enterprise Edge telephone:

1. Press . The display shows **Alrm: 07:00am OFF**.

If the alarm time is correct press **ON/OFF**. The display shows **Alrm:07:00am ON**. Press **DONE** to exit.

or

To enter a new alarm time press **CHG**. The display shows **Enter time:**.

2. Enter a new 4 digit alarm time.

If the 24 hour clock format is used (hour: 00 to 23 and minutes: 00 to 59), no confirmation is required. The display shows **Alarm ON hh:mm**.

If the 12 hour format is used, the display shows **hh:mm AM or PM?**. Press the **AM** or **PM** display key. The display shows **Alarm ON hh:mm**.

To program the Alarm time feature on an analog telephone:

1. Press . A tone sounds.
2. Enter a 4 digit alarm time.

If the 24 hour clock format is used (hour: 00 to 23 and minutes: 00 to 59), a tone sounds.

If the 12 hour format is used, press to select am or to select pm. A tone sounds.

At the selected times, sets in the room ring to wake-up or remind the occupant of the next event or meeting.

Changing or canceling an earlier selected Alarm time

To set a new time for an Alarm time, re-enter a new Alarm time. The new time overwrites any earlier set time. Canceling the Alarm time for any set cancels the Alarm time for all the sets in the same room.

Canceling the alarm

- To cancel the Alarm time on an Enterprise Edge telephone, press . The display shows **Alarm OFF**.
- To cancel the Alarm time on an analog telephone press .

Turning off the Alarm

When a set rings at the selected time, the occupant can release the Alarm ring as follows:

- On an Enterprise Edge telephone, press any button except the button.
- On an analog telephone lift and replace the handset back into position.

Note: If the user presses the button when the set rings, it temporarily deactivates the Alarm. After a number of minutes, the set will alert again. If the user is on a call when the alarm sounds they can press any key except Release to cancel the alarm and maintain their active call.

Hospitality Services admin alarm feature

Only a Hospitality Services (HS) admin set can use the Hospitality Services admin alarm feature. The Hospitality Services admin alarm feature is room oriented only, it does not control the alarms on common sets.

The Hospitality Services admin feature can:

- query the current or last alarm time set for a room
- overwrite previous Alarm time programming for a room on the system
 - assign an Alarm time for any room on the system
 - change an Alarm time for any room on the system
 - cancel an Alarm pending for any room on the system

To program the Alarm time for a room with the Hospitality Services admin alarm feature:

1. Press on a two-line display Enterprise Edge telephone (M7310 or M7324).
2. If configured, the display shows **Password:**. Enter the Desk admin password.
3. The display shows **Al of rm#:**. Enter the room number.
4. Press VIEW. The display shows **Alarm: 07:00am OFF:**. If the alarm time is correct press the **ON/OFF** display key to activate the alarm.
5. Enter a four digit alarm time.

If the 24 hour format is used (hour: 00 to 23 and minutes: 00 to 59), no confirmation is required. The display shows **Alarm hh:mm ON.**

If the 12 hour format is used, the display shows the four digit time plus **AM or PM?**. Press the AM or PM display key. The display shows **Alarm hh:mm am or PM ON.**

6. Press the Release button to exit programming.

Room occupancy (RO)

The Room occupancy (RO) feature allows front desk operators to assign dialing restrictions to room sets, and also works with the Room condition (RC) feature. Dialing restrictions for room sets are defined in the Unified Manager. See the *Enterprise Edge Programming Operations Guide*. The RO feature does not apply to common sets.

The RO feature uses the following room states: Vacant filter, Basic filter, Mid filter, and Full filter. A variety of dialing filters can be configured for each room state. The default setting is **Vacant**.

- **Vacant** — Room is empty.
- **Basic** — Room is occupied.
- **Mid** — Room is occupied.
- **Full** — Room is occupied.

Programming the state of a room set

To access the Room Occupancy feature and assign the state of a room set:

1. Press on a two-line display Enterprise Edge telephone (M7310 or M7324).
2. If configured, the display shows **Password:**. Enter the Desk admin password.
3. The display shows **Occ of rm#:**. Enter the room number and press OK.
4. The display shows **rrrrr:Vacant**. Press the **CHANGE** display key and select the required status for the room set: Vacant, Basic, Mid or Full. The default setting is **Vacant**.
5. To program other rooms, press the **FIND** or **NEXT** display key and return to step 3. If no more rooms require programming, press the Release button to exit programming.

Note: Programming a room to Vacant state cancels any outstanding alarms.

Room condition (RC)

The Room condition (RC) feature allows users to exchange information about the serviced state of a room. Users are front desk attendants, and cleaning or maintenance personnel of an establishment. The RC feature is not available from a common set.

The Enterprise Edge system maintains a database of the state of each room. This database is accessed from either the room set or a Hospitality Services admin set.

Room sets can:

- set the associated room's state to Service done (**Srvc done**)

- set the associated room's state to Needs service (**Needs srvc**)
- query the state of the associated room on a set with a display.

Front desk sets can:

- set any room's state to Service done (**Srvc done**)
- set any room's state to Needs service (**Needs srvc**)
- query the state of any room.

The system changes the state of occupied rooms to Needs service on a daily basis at a set time as configured in the system.

Maintenance personnel program the condition of the room to Service done when service in the room is complete.

The front desk attendant can query or program the condition of a room with a Hospitality Services admin set. The Enterprise Edge system automatically sets the status of a room to **Needs srvc**, when a Room occupancy status changes from occupied to **Vacant**.

Room condition from a room set

To update the Room condition using a room set:

1. Press **Feature** **8** **7** **6** on an Enterprise Edge telephone or press **Link** ***** **8** **7** **6** on an analog telephone.
2. At the prompt, enter the status of the room.
3. Press **1** on the dialpad to indicate **Set to srvc done**. If required, enter the Room condition password.
or,
Press **2** on the dialpad to indicate **Set to needs srvc**. If required, enter the Room condition password.
4. The display shows **Set to srvc done** or **Set to needs srvc**.

Room condition with a Hospitality service admin set

To update or query the Room condition using a HS admin set:

1. Press **Feature** **8** **7** **8** on a two-line display Enterprise Edge telephone (M7310 or M7324).
2. If configured, the display shows **Password:**. Enter the Desk admin password.
3. The display shows **Cd of rm#:**. Enter the room number and press OK.

4. The display shows `rrrrr:Vacant`. Press the **CHANGE** display key and select the required status for the room set: if the room is occupied, select **Srvc done** or **Needs srvc**; if the room is vacant, select **Vacant** or **Needs srvc**. The default setting is **Vacant**.
5. To update or query other room sets, press the **FIND** or **NEXT** display key and return to step 3. If there are no more room sets updates or queries, press the Release button to exit programming.

Hospitality programming

Hospitality passwords

The Hospitality Services feature allows for two types of passwords to access different areas of Hospitality programming.

Desk admin password

The Desk password is used to access all Hospitality Services admin features. The default Desk password is: (**4677**). You need to start a Unified Manager session to program to change the default Desk password. For more information about programming using the Unified Manager, see the *Enterprise Edge Programming Operations Guide*.

Room condition password

The Room condition password controls the ability to change the room condition with . The default room condition password is: **None**. Different from the Desk password, the room condition password can remain as None.

You need to start a Unified Manager session to change the default Room condition password. For more information about programming using the Unified Manager, see the *Enterprise Edge Programming Operations Guide*.

Two portable telephones are supported in Enterprise Edge: the Companion C3050 Etiquette and the Companion C3050 CT2Plus.

Using your portable telephone

Your portable telephone communicates with the Enterprise Edge system using radio waves. The radio transceivers for the system are located in the Base Stations installed around your office. Each Base Station contains two radio transceivers and can handle two portable telephone calls at once.

Your portable telephone is truly portable. Not only can you start a telephone conversation anywhere in the office, you can continue that conversation while you walk through the building. As you move from one part of your office to another, your call is handed off from one Base Station to another.

If you notice a decrease in voice quality while moving with a portable telephone, you are moving out of range of your system's Base Stations. There are three possible reasons for this:

- The Base Stations that cover the area you are moving into may already be busy and therefore cannot pick up your call.
- Large pieces of furniture or movable partitions may have been moved into a position that blocks the signal between you and the Base Station.
- You may have moved out of the area covered by your Enterprise Edge system. (Retrace your steps until you are back in range.)

In *rare* instances, during an Enterprise Edge Message session, softkey display prompts on your portable may disappear. This is a normal condition and is minimized by staying within the Enterprise Edge coverage area.

While *moving* within an Enterprise Edge coverage area, a slight “clipping” may be heard during a call. This indicates that your call has been “handed off” from one radio cell to the next.

Problems with lost connections are rare, but if you notice an increase of such incidents after making large changes in the layout of your office, your Base Stations may need to be moved or reprogrammed to accommodate the new arrangement. In this case, contact your installer to change the Base Station configuration. (In the U.S. you need to obtain UTAM Inc. approval before making changes to the Base Station configuration.) Refer to *Enterprise Edge Programming Operations Guide* for more information.

**Tip**

If you try to send a message from a desk telephone to a portable telephone, the display of the desk telephone shows `Can't send msg.`

Using Enterprise Edge features

It is possible to use many of the same Enterprise Edge features available to an Enterprise Edge telephone on your portable telephone. The table below lists which features are available for use on your portable telephone. For additional information on features and the special key sequences required to use them, refer to the feature card that is supplied with your portable telephone.

Features supported by Enterprise Edge portable telephones

Feature	Description
Call Forward	Send calls to another telephone in your Enterprise Edge system. The display does not indicate that calls are being forwarded. Hunt Group calls override all Call Forward features. A Hunt Group DN can be a Call Forward destination.
Call Information	Display the name or extension of an internal caller. In addition, if your system is equipped to receive CLASS information (Caller ID), the external caller is displayed.
Call Park	On your portable, park a call.
Call Park Retrieval	On your portable, retrieve a parked call.
Cancel Call Forward	Cancel the Call Forward feature, where calls are automatically sent to another telephone in your Enterprise Edge system.
Conference	See your <i>Portable Telephone Feature Card</i> .
Directed Call Pickup	Answer any telephone that is ringing in your Enterprise Edge system.
Group Pickup	Answer a call ringing on another set in the same pickup group.
Host system signaling	Link and pause are available. See "Using System features" on page 95 for more information.
Line Pool	On your portable, use line pools the same way a desk telephone does.
Mute	Prevent the person you are on the portable telephone with from hearing you. Also, you can mute a portable's ringing for an incoming call.
Page	On your portable, page an individual telephone, several telephones, external speakers, or the entire system. A Hunt Group DN cannot be in a page zone.
Pause	Program in an external autodial sequence to insert a 1.5 second delay.
Prime line	On your portable, may be either an Intercom Line, an Assigned Line or a Line Pool.

Feature	Description
Priority call	See "Supporting additional features for portables" on page 120. Hunt Groups reject priority calls.
Privacy	In programming, change the privacy setting for an external line assigned to the portable. This does not give the ability to change the privacy setting on a call by call basis.
Release	See your <i>Portable Telephone Feature Card</i> .
Speed Dial	System speed dial codes only. No personal speed dial codes. The portable has a directory that you can use to store up to 50 entries for telephone numbers.
Switching between two calls	When on a portable call, switch to another incoming call. You can then switch back to the first call. See your <i>Portable Telephone Feature Card</i> .
Transfer	See your <i>Portable Telephone Feature Card</i> .
Transfer using directory	Transfer a call using your portable's directory. See your <i>Portable Telephone Feature Card</i> .
Trunk Answer	Grab a ringing call for lines placed in a Service Mode.
Voice call	See "Supporting additional features for portables" on page 120. Hunt Groups reject voice calls.
Wireless Portable Language Selection	Change the language of the prompts as they appear on the portable's display.
Wireless Call Forward No Answer	Stop the portable from ringing when the call has been forwarded to its new destination. The portable user can still answer the call but it does not ring.

Using new features

Directed Call Pickup

You must turn on the Directed Call pickup feature for the system before a user can use the feature. The *Enterprise Edge Programming Operations Guide* contains additional programming information for this feature.

Group Pickup

Group Pickup allows the portable user to answer a call ringing on another set in the same pickup group. The *Enterprise Edge Programming Operations Guide* contains additional programming information for this feature.

Wireless Portable Language Selection

This feature allows you to change the language as they appear on the portable's display, including both the display prompts and voice prompts from voice mail.

Enterprise Edge supports English, French and Spanish.

English

Press .

French

Press .

Spanish

Press * * 5 0 3 .

Wireless Call Forward No Answer enhancement

This improvement stops the portable from ringing when the call has been forwarded to its new destination. The portable user can still answer the call, but it does not ring. The *Enterprise Edge Programming Operations Guide* contains additional programming information for this feature.

Supporting additional features for portables

Two additional Enterprise Edge features can be used with a portable if lines and hardware (an Enterprise Edge ATA2) are specifically configured to support them:

- Voice Call (* 6 6)
- Priority Call (* 6 9)

Your installer can set up and program your system to support these features.

Refer to the *Portable Telephone Feature Card* that is supplied with the portable for the special key sequence required to use this set of features.

Using the alarm telephone

An alarm telephone displays Enterprise Edge's system alarm codes, should they occur. It is an Enterprise Edge telephone with a two-line display (M7310 or M7324 telephones) that the installer has assigned as an alarm telephone.

Note: Alarms are also stored in the WinNT Network Event log. For more information, see the *Enterprise Edge Programming Operations Guide*.

Reporting and recording alarm codes

If an alarm message appears on the alarm telephone's display:

1. Record the alarm number.
2. Call your customer service representative and report the alarm code.

Displays

Alarm:	61-4-2	Report this alarm and the time it occurred to your installer or customer service representative.
TIME		

Testing the telephone

If you suspect something is wrong with a button, the speaker, the displays, or some other part of the Enterprise Edge telephone hardware, you can do a quick test to see which part of the telephone is broken.



Tips

Ensure that the function of a button matches its label by pressing * and then the button to see its function.

You can end the telephone testing session anytime by pressing or unless you are testing those buttons. The test feature times-out after 30 minutes of no activity.

Testing the telephone display

Use a display test if you suspect that one of the indicators on the telephone is not working.

1. Press . The display reads `Display test`.
2. Press TEST or to go ahead with a display test.
3. Adjust the contrast for the telephone display so you are able to see the test results clearly. Enter a number to change the contrast or press DOWN and UP.
4. Press OK or to go ahead with the test.

During the test, the display should be filled with solid, dark blocks and all the indicators next to the buttons on the telephone should be turned on. Any Busy Lamp Field (BLF) or CAP modules that are attached to the telephone should be completely lit. You lose any information that was showing on the BLF before the test started.

Pressing any button ends the test.

Testing the telephone buttons

1. Press , then or NEXT.
2. Press TEST or to go ahead with a button test.
3. Press button to see its function. If the button you pressed uses an indicator, it should turn on when you test the button.
4. Pressing the button puts `Rls button` on the display briefly and returns you to the `Button test` display.

Testing the speaker in the telephone handset

The handset test is not available if you have a headset plugged into the telephone.

1. Press , then or NEXT twice. The display reads `Handset test`.
2. Press TEST or to go ahead with a handset test.
3. Pick up the handset and listen. You should hear dial tone through the handset at a maximum volume. The volume is reset to maximum only while the test is going on.

Pressing any button or hanging up ends the test.

Testing the telephone headset

The headset test is not available to telephones that do not have a headset jack or a headset plugged in.

1. Press , then or **NEXT** until the display reads **Headset test**.
2. Press **TEST** or to go ahead with a headset test.

You should hear dial tone through the headset. The volume is reset to a default level during the test.

Pressing any button ends the test.

Testing the telephone speaker

1. Press , then or **NEXT** until the display reads **Speaker test**.
2. Press **TEST** or to go ahead with a speaker test.

You should hear page tone through the telephone speaker at the maximum volume. The volume returns to its previous setting when you end the test.

Pressing any button ends the test.

Testing the power supply to a telephone

1. Press , then or **NEXT** until the display reads **Power test**.
2. Press **TEST** or to go ahead with a power supply test.

You should see all the indicators on the telephone go on and hear ringing at maximum volume. When the test has ended, the display should briefly show **Power OK**.

The test lasts for five seconds or until you press a button.

You may see the following displays when you use a feature.

Access denied	Someone is already using programming, or the feature you are trying to use is not compatible with the configuration of the telephone or line.
Denied in admin	You have tried to use a feature, but you have not been given access to it in administration programming.
Feature timeout	You have taken more than 15 seconds to press a button in response to a display.
Inactive feature	You have entered a feature code that is used by an application program that your system does not have.
Invalid code	You have entered an invalid feature code.
Not available	You have tried to use a feature that is not available in the present setup of your Enterprise Edge system.
Set locked	You cannot use the feature you have chosen because your telephone is locked. See "Using Set lock" on page 100.
1234567890123... VIEW_ OK	Press # or press VIEW_ or +VIEW_ to view a number that is too long to fit on the display. Press Hold or OK when you are finished.
5	This indicates a long distance call. (May be available with Call Display services.)
239>221	You are receiving an internal call from telephone 239 forwarded by telephone 221 or you have an Answer button for telephone 221 and an internal call from 239 is ringing on 221.
221 TRANSFER	You are connected to an internal call. Press TRANSFER to transfer the call.
221 calling	You are receiving a call from telephone 221.
Call 221? YES NO	You have received a Ring Again offer for a call to an internal telephone. Press the flashing internal line button or YES to call the number again. On the M7100 telephone, just lift the receiver. Otherwise, press NO or wait 30 seconds for the Ring Again offer to expire. For an explanation of Ring Again, see "Using Ring Again" on page 36.
Camped: 221 CALLBACK	The person has not answered the camped call. The call has come back to you. Press the line button or CALLBACK to reconnect to the call.

Line061 TRANSFER	You are connected to an external call. Press <u>TRANSFER</u> to transfer the call.
Line061>221	You are receiving an external call forwarded from telephone 221 or you have an answer button for telephone 221 and an external call is ringing on that telephone.
Line061 transfer	The call on line 061 is being transferred to you by someone else in your Enterprise Edge system.
Line061 waiting	A camped call is waiting. Press the line button or use Call Queuing to answer the call. Press <input type="text" value="Hold"/> if you have a M7100 telephone.
No calls waiting	You tried to use Call Queuing but no call was ringing at your telephone.
No line selected	There is no call ringing at your telephone. If you have a flashing line button but your telephone is not ringing, press the line button to answer the call on that line.
Not in service	The telephone to which you directed a call is not in service or is otherwise unavailable. The call is returned to your telephone.
Parked call CALLBACK	No one answered the call you parked. The call has come back to you.
Pick up receiver	You have used the Call Queuing feature without picking up the receiver. Auto Handsfree has not been assigned to your telephone. You must use the receiver or <input type="text" value="Handsfree Mute"/> to answer a call.
Priority> 221 BLOCK	You are receiving a priority call. If you are on another call, inform the person you are speaking to that you are about to put the call on hold. Press the flashing line indicator of the priority call or wait until the call connects automatically (in eight seconds). The priority call goes through when you hear the next beep. Your active call is placed on Exclusive Hold. It is reconnected automatically when the priority call ends (unless you transfer the priority call, in which case you must press the line button of your original call to reconnect). Use DND (<input type="text" value="Feature"/> <input type="text" value="8"/> <input type="text" value="5"/>) or press <u>BLOCK</u> to reject a priority call.
Release a call	You have no free line buttons on which to receive a call. Release one of your current calls and try again to answer the incoming call.
Use line pool? YES NO	You have received a Ring Again offer for a line pool. Press the flashing internal line button or <u>YES</u> to use the line pool. On the M7100 telephone, just lift the receiver. Otherwise, press <u>NO</u> or wait 30 seconds for the Ring Again offer to expire.
Hold or release	You cannot program a feature button while you are on a call.
Release calls	You have tried to use a feature while you were on a call or had calls on hold. Release the call or calls, before using the feature.
Line in use	The line is in use. Make the call using normal methods or wait until the line is free.
No button free	You have tried to make, receive or pick up a call when no line button was available. Some features require you to have a button free. Releasing calls can free up line buttons.

Make calls first	The feature you tried to use requires you to be on an active call at your telephone. This display appears when information about a call has been cleared by a system reset.
No free lines	All the lines or line pools available to the telephone are in use. This display appears when you have tried to dial an external number or use a feature that conflicts with the lines, line pools or prime line used by the telephone. This must be corrected by your installer.
No line selected	The telephone has been set up to dial an external number on a prime line but the telephone does not have a prime line. This must be corrected by your installer.
In use:221	You have tried to program redirection while someone else is programming redirection. Only one person can program line redirection at a time.
Incoming only	The line you are trying to use for redirecting calls is for incoming calls only. Choose an outgoing line.
9_ QUIT BKSP OK	Continue entering digits. Press <input type="text"/> or BKSP to delete incorrect digits. Press <input type="text"/> or OK when you are finished.
Invalid number	You have entered an invalid line pool code or an invalid destination code.
Line denied	You have selected a line that is private to another telephone.
Restricted call	The destination you have chosen for line redirection is restricted.

The following appendix provides a quick reference for Enterprise Edge features that are available by pressing the button. Two tables are provided, one sorted alphabetically by feature name and the other sorted numerically by feature code.

Features sorted by feature name

Feature name	Activation code
Alarm time	<input type="text" value="Feature"/> * 8 7 5
Alarm time - Cancel	<input type="text" value="Feature"/> # 8 7 5
Alarm time (HS admin set)	<input type="text" value="Feature"/> * 8 7 7
Autodial - External	<input type="text" value="Feature"/> * 1
Autodial - Internal	<input type="text" value="Feature"/> * 2
Background Music	<input type="text" value="Feature"/> 8 6
Background Music - Cancel	<input type="text" value="Feature"/> # 8 6
Button inquiry	<input type="text" value="Feature"/> * 0
Call Duration Timer	<input type="text" value="Feature"/> 7 7
Call Forward	<input type="text" value="Feature"/> 4
Call Forward - Cancel	<input type="text" value="Feature"/> # 4
Call Information	<input type="text" value="Feature"/> 8 1 1
Call Log - Delete items	<input type="text" value="Feature"/> 8 1 5
Call Log - Manual	<input type="text" value="Feature"/> 8 1 3
Call Log - View information	<input type="text" value="Feature"/> 8 1 2
Call Log options	<input type="text" value="Feature"/> * 8 4
Call Log password	<input type="text" value="Feature"/> * 8 5
Call Park	<input type="text" value="Feature"/> 7 4
Call Queuing	<input type="text" value="Feature"/> 8 0 1
Camp-on	<input type="text" value="Feature"/> 8 2
Class of Service	<input type="text" value="Feature"/> 6 8
Conference Call	<input type="text" value="Feature"/> 3
Conference Call - Splitting	<input type="text" value="Feature"/> # 3
Contrast adjustment	<input type="text" value="Feature"/> * 7
Current Time & Date	<input type="text" value="Feature"/> 8 0 6
Current Time & Date - Cancel	<input type="text" value="Feature"/> # 8 0 6
Dialing Mode	<input type="text" value="Feature"/> * 8 2
Directed Pickup	<input type="text" value="Feature"/> 7 6
Do not Disturb	<input type="text" value="Feature"/> 8 5

Feature name	Activation code
Do not Disturb - Cancel	Feature <input type="text" value=""/> # <input type="text" value="8"/> <input type="text" value="5"/>
Exclusive Hold	Feature <input type="text" value=""/> <input type="text" value="7"/> <input type="text" value="9"/>
Group Listening	Feature <input type="text" value=""/> <input type="text" value="8"/> <input type="text" value="0"/> <input type="text" value="2"/>
Group Listening - Cancel	Feature <input type="text" value=""/> # <input type="text" value="8"/> <input type="text" value="0"/> <input type="text" value="2"/>
Group Pickup	Feature <input type="text" value=""/> <input type="text" value="7"/> <input type="text" value="5"/>
Language - English ¹	Feature <input type="text" value=""/> * <input type="text" value="5"/> <input type="text" value="0"/> <input type="text" value="1"/>
Language - French ¹	Feature <input type="text" value=""/> * <input type="text" value="5"/> <input type="text" value="0"/> <input type="text" value="2"/>
Language - Spanish ¹	Feature <input type="text" value=""/> * <input type="text" value="5"/> <input type="text" value="0"/> <input type="text" value="3"/>
Last Number Redial	Feature <input type="text" value=""/> <input type="text" value="5"/>
Line buttons - Move	Feature <input type="text" value=""/> * <input type="text" value="8"/> <input type="text" value="1"/>
Line Pool	Feature <input type="text" value=""/> <input type="text" value="6"/> <input type="text" value="4"/>
Line Redirection	Feature <input type="text" value=""/> <input type="text" value="8"/> <input type="text" value="4"/>
Line Redirection - Cancel	Feature <input type="text" value=""/> # <input type="text" value="8"/> <input type="text" value="4"/>
Link	Feature <input type="text" value=""/> <input type="text" value="7"/> <input type="text" value="1"/>
Long tones	Feature <input type="text" value=""/> <input type="text" value="8"/> <input type="text" value="0"/> <input type="text" value="8"/>
Memory buttons - Program	Feature <input type="text" value=""/> * <input type="text" value="3"/>
Messages - Send	Feature <input type="text" value=""/> <input type="text" value="1"/>
Messages - Cancel Send	Feature <input type="text" value=""/> # <input type="text" value="1"/>
Messages - View	Feature <input type="text" value=""/> <input type="text" value="6"/> <input type="text" value="5"/>
Name and number blocking	Feature <input type="text" value=""/> <input type="text" value="8"/> <input type="text" value="1"/> <input type="text" value="9"/>
Page	Feature <input type="text" value=""/> <input type="text" value="6"/> <input type="text" value="0"/>
Page - Combined (internal & external)	Feature <input type="text" value=""/> <input type="text" value="6"/> <input type="text" value="3"/>
Page - External (external speakers)	Feature <input type="text" value=""/> <input type="text" value="6"/> <input type="text" value="2"/>
Page - Internal (telephone speakers)	Feature <input type="text" value=""/> <input type="text" value="6"/> <input type="text" value="1"/>
Pause	Feature <input type="text" value=""/> <input type="text" value="7"/> <input type="text" value="8"/>
Priority Call	Feature <input type="text" value=""/> <input type="text" value="6"/> <input type="text" value="9"/>
Privacy (on/off)	Feature <input type="text" value=""/> <input type="text" value="8"/> <input type="text" value="3"/>
Programmed Release	Feature <input type="text" value=""/> * <input type="text" value="8"/> <input type="text" value="9"/>
Ring Again	Feature <input type="text" value=""/> <input type="text" value="2"/>
Ring Again - Cancel	Feature <input type="text" value=""/> # <input type="text" value="2"/>
Ring Type	Feature <input type="text" value=""/> * <input type="text" value="6"/>
Ring Volume	Feature <input type="text" value=""/> * <input type="text" value="8"/> <input type="text" value="0"/>
Room condition (Room set)	Feature <input type="text" value=""/> <input type="text" value="8"/> <input type="text" value="7"/> <input type="text" value="6"/>
Room condition (HS admin set)	Feature <input type="text" value=""/> <input type="text" value="8"/> <input type="text" value="7"/> <input type="text" value="8"/>
Room occupancy	Feature <input type="text" value=""/> <input type="text" value="8"/> <input type="text" value="7"/> <input type="text" value="9"/>
Run/Stop	Feature <input type="text" value=""/> * <input type="text" value="9"/>

Feature name	Activation code
Saved Number Redial	Feature <input type="text" value="6"/> <input type="text" value="7"/>
Speed Dial - Add, change	Feature <input type="text" value="*"/> <input type="text" value="4"/>
Speed Dial - Make	Feature <input type="text" value="0"/>
Test telephone display	Feature <input type="text" value="8"/> <input type="text" value="0"/> <input type="text" value="5"/>
Time	Feature <input type="text" value="8"/> <input type="text" value="0"/> <input type="text" value="3"/>
Transfer	Feature <input type="text" value="7"/> <input type="text" value="0"/>
Transfer - Cancel	Feature <input type="text" value="#"/> <input type="text" value="7"/> <input type="text" value="0"/>
Trunk Answer	Feature <input type="text" value="8"/> <input type="text" value="0"/> <input type="text" value="0"/>
Turning Restriction service off	Feature <input type="text" value="#"/> <input type="text" value="8"/> <input type="text" value="7"/> <input type="text" value="2"/>
Turning Restriction service on	Feature <input type="text" value="8"/> <input type="text" value="7"/> <input type="text" value="2"/>
Turning Ringing service off	Feature <input type="text" value="#"/> <input type="text" value="8"/> <input type="text" value="7"/> <input type="text" value="1"/>
Turning Ringing service on	Feature <input type="text" value="8"/> <input type="text" value="7"/> <input type="text" value="1"/>
Turning Routing service off	Feature <input type="text" value="#"/> <input type="text" value="8"/> <input type="text" value="7"/> <input type="text" value="3"/>
Turning Routing service on	Feature <input type="text" value="8"/> <input type="text" value="7"/> <input type="text" value="3"/>
View active services	Feature <input type="text" value="8"/> <input type="text" value="7"/> <input type="text" value="0"/>
Voice Call	Feature <input type="text" value="6"/> <input type="text" value="6"/>
Voice Call Deny	Feature <input type="text" value="8"/> <input type="text" value="8"/>
Voice Call Deny - Cancel	Feature <input type="text" value="#"/> <input type="text" value="8"/> <input type="text" value="8"/>
Wait for dial tone	Feature <input type="text" value="8"/> <input type="text" value="0"/> <input type="text" value="4"/>
Notes ¹ For the Companion C3050 Etiquette and C3050 CT2Plus portable telephones, enter <input type="text" value="*"/> <input type="text" value="*"/> followed by the numeric code to activate this feature.	

Features sorted by activation code

Activation code	Description
Feature 0	Speed Dial - Make
Feature * 0	Button inquiry
Feature 1	Messages - Send
Feature # 1	Messages - Cancel Send
Feature * 1	Autodial - External
Feature 2	Ring Again
Feature # 2	Ring Again - Cancel
Feature * 2	Autodial - Internal
Feature 3	Conference Call
Feature # 3	Conference Call - Splitting
Feature * 3	Memory buttons - Program
Feature 4	Call Forward
Feature # 4	Call Forward - Cancel
Feature * 4	Speed Dial - Add, change
Feature 5	Last Number Redial
Feature * 6	Ring Type
Feature * 7	Contrast adjustment
Feature * 9	Run/Stop
Feature 6 0	Page
Feature 6 1	Page - Internal (telephone speakers)
Feature 6 2	Page - External (external speakers)
Feature 6 3	Page - Combined (internal & external)
Feature 6 4	Line Pool
Feature 6 5	Messages - View
Feature 6 6	Voice Call
Feature 6 7	Saved Number Redial
Feature 6 8	Class of Service
Feature 6 9	Priority Call
Feature 7 0	Transfer
Feature # 7 0	Transfer - Cancel
Feature 7 1	Link
Feature 7 4	Call Park
Feature 7 5	Group Pickup
Feature 7 6	Directed Pickup
Feature 7 7	Call Duration Timer

Activation code	Description
Feature 7 8	Pause
Feature 7 9	Exclusive Hold
Feature * 8 0	Ring Volume
Feature * 8 1	Line buttons - Move
Feature 8 2	Camp-on
Feature * 8 2	Dialing Mode
Feature 8 3	Privacy (on/off)
Feature 8 4	Line Redirection
Feature # 8 4	Line Redirection - Cancel
Feature * 8 4	Call Log options
Feature 8 5	Do not Disturb
Feature # 8 5	Do not Disturb - Cancel
Feature * 8 5	Call Log password
Feature 8 6	Background Music
Feature # 8 6	Background Music - Cancel
Feature 8 8	Voice Call Deny
Feature # 8 8	Cancel Voice Call Deny
Feature * 8 9	Programmed Release
Feature * 5 0 1	Language - English ¹
Feature * 5 0 2	Language - French ¹
Feature * 5 0 3	Language - Spanish ¹
Feature 8 0 0	Trunk Answer
Feature 8 0 1	Call Queuing
Feature 8 0 2	Group Listening
Feature # 8 0 2	Group Listening - Cancel
Feature 8 0 3	Time
Feature 8 0 4	Wait for dial tone
Feature 8 0 5	Test telephone display
Feature 8 0 6	Current Time & Date
Feature # 8 0 6	Current Time & Date - Cancel
Feature 8 0 8	Long tones
Feature 8 1 1	Call Information
Feature 8 1 2	Call Log - View information
Feature 8 1 3	Call Log - Manual
Feature 8 1 5	Call Log - Delete items
Feature 8 1 9	Name and number blocking

Activation code	Description
Feature <input type="text" value="8"/> <input type="text" value="7"/> <input type="text" value="0"/>	Viewing active services
Feature <input type="text" value="8"/> <input type="text" value="7"/> <input type="text" value="1"/>	Turning Ringing service on
Feature <input type="text" value="#"/> <input type="text" value="8"/> <input type="text" value="7"/> <input type="text" value="1"/>	Turning Ringing service off
Feature <input type="text" value="8"/> <input type="text" value="7"/> <input type="text" value="2"/>	Turning Restriction service on
Feature <input type="text" value="#"/> <input type="text" value="8"/> <input type="text" value="7"/> <input type="text" value="2"/>	Turning Restriction service off
Feature <input type="text" value="8"/> <input type="text" value="7"/> <input type="text" value="3"/>	Turning Routing service on
Feature <input type="text" value="#"/> <input type="text" value="8"/> <input type="text" value="7"/> <input type="text" value="3"/>	Turning Routing service off
Feature <input type="text" value="*"/> <input type="text" value="8"/> <input type="text" value="7"/> <input type="text" value="5"/>	Alarm time
Feature <input type="text" value="#"/> <input type="text" value="8"/> <input type="text" value="7"/> <input type="text" value="5"/>	Alarm time - Cancel
Feature <input type="text" value="8"/> <input type="text" value="7"/> <input type="text" value="6"/>	Room condition (Room set)
Feature <input type="text" value="*"/> <input type="text" value="8"/> <input type="text" value="7"/> <input type="text" value="7"/>	Alarm time (HS admin set)
Feature <input type="text" value="8"/> <input type="text" value="7"/> <input type="text" value="8"/>	Room condition (HS admin set)
Feature <input type="text" value="8"/> <input type="text" value="7"/> <input type="text" value="9"/>	Room occupancy
Notes ¹ For the Companion C3050 Etiquette and C3050 CT2Plus portable telephones, enter <input type="text" value="*"/> <input type="text" value="*"/> followed by the numeric code to activate this feature.	

Symbols

- ☎ Long Distance symbol 125
- ☎ Link symbol 101
- ⏸ Pause symbol 102
- ☎ Programmed Release symbol 102
- ⏸ Run/Stop symbol 103
- ☎ Wait for Dial Tone symbol 103
- 2-way DID
 - PRI 90
- 911 11, 87, 90

A

- access
 - Class of Service 106
 - Enterprise Edge from outside the system 103
 - external lines 108
 - remote 105
 - using a COS 104
 - using a DISA 104
- Access denied 125
- ADD 110
- Admin alarm time 113
- Alarm 61-4-2 121
- alarm codes, reporting and recording 121
- alarm telephone 121
- Alarm time 111
- Allow calls 88
- allow redirect
 - programming 55
- Already joined 21, 31
- Already Parked 49
- alternate services 95
- analog telephone
 - replying to a message 63, 64
- analog telephones
 - sending messages 61
- Analog terminal adaptor
 - using dialing modes 34
- announcement
 - paging 59
 - Voice Call 65
- Answer button 22
- answering calls
 - Answer button 22
 - Call Display services 18
 - Call Duration Timer 29
 - Call Pickup 20
 - CAP 17

- Conference Calls 23
 - Group Listening 26
 - Handsfree 26
 - hearing aid compatibility 18
 - prime telephone 16
 - Privacy 29
 - Trunk Answer 21
 - using line buttons 15
 - using the Release button 18
 - Voice Call 65
 - apply button cap labels 76
 - ASM
 - Long tones 102
 - Auto Call information (see Caller ID set)
 - Autodial
 - for M7100 37
 - line selection 37
 - programming 37
 - storing number on a memory button 37
 - using intercom line for 38
 - using Last Number Redial 39
 - Autodial full 38
 - automatic
 - Call information 19
 - Call Log 67
 - dial 34
 - Handsfree 28
 - Hold 43
 - release of a line (see Disconnect Supervision)
 - Automatic Call Back, ISDN feature 92
 - Automatic Call Forward
 - changing settings 52
 - Automatic Recall
 - ISDN terminal feature 93
 - Automatic Telephone Relocation 87, 107
 - auxiliary ringer 101
- B**
- Background Music 88
 - turning off 88
 - BKSP 110
 - blocking calls (see Do Not Disturb)
 - busy 31, 36
 - busy tone, fast 105
 - button cap labels 76
 - applying 76
 - button caps 76
 - button defaults

- M7100 telephone 79
- M7208 telephone 78
- M7310 telephone 78
- M7324 telephone 79
- Button erased 38
- Button Inquiry 73
- buttons
 - Answer button 22
 - Button Inquiry 73
 - display 12, 13
 - dual memory 13
 - erasing programmed features 75
 - Feature 13
 - Handsfree/mute 28
 - Hold 13
 - Last Number Redial 39
 - memory 13, 37, 109
 - moving line 79
 - programming features on 74
 - Release 13, 18
 - Saved Number Redial 42
 - shift 13
 - testing 121, 122
 - using a line button 32
- bypassing
 - a Hotline telephone 99
- C**
- call
 - overflow 108
 - ways to make a 31
- Call 221? 125
- Call blocked 35
- Call by Call
 - PRI 91
- Call Display information 18
- Call Duration Timer 29
- Call Forward
 - and Line Redirection, differences 57
 - automatic, changing settings 52
 - Call Forward on Busy 52
 - canceling 51
 - Forward no answer 52
 - ISDN terminal feature 92
 - overriding 52
 - programming 52
 - to voice mail 53
 - using 51
- Call information
 - automatic 19
 - changing what is shown first 20
 - displaying information 18
 - getting information for a call on hold 19
 - getting information for a current call 19
- Call Log 67
 - Autobumping 68
 - automatic 67
 - calling from within 69
 - deleting log items 68
 - logging a call manually 68
 - options 68
 - password 70
 - canceling 70
 - changing 70
 - set 67
 - using 67
- Call Park 48
- Call Pickup
 - Directed Pickup 20
 - Group Pickup 20
- Call Queuing 44
- Call Transfer 45–47
- Call(s) bumped 71
- Callback 50
- Caller ID set 19
- Calling 36
- calls, switching between 119
- Camp denied 47
- Camp max 47
- Camp to 47
- Camped 48, 125
- camping calls (see Camp-on)
- Camp-on 47
- Can't ring again 31, 36
- CANCEL 110
- Cancel denied 64
- canceling
 - a transfer 46
 - Call Forward 51
 - Do Not Disturb 87
 - Group Listening 26
 - Line Redirection 55
- CAP (central answering position)
 - answering calls 17
 - customizing 17
 - M7324 telephone 17
 - monitoring calls 17
 - telephone 17, 98
 - using 17
- central answering position (see CAP)
- changing settings
 - automatic Call Forward 52
- Class of Service
 - changing 106
 - using a password 104, 106
- Cleared>LINENAM 64

- communicating in the office
 - paging 59–61
 - sending messages using display 61
 - Voice Call 65
- Conf. on hold** 25
- Conference busy** 25
- Conference Call**
 - by releasing privacy 29
 - disconnecting from 25
 - removing yourself from 25
 - splitting 24
 - using the Conference feature 23
- contrast adjustment 73
- control telephone 96, 100
- customizing CAP 17
- customizing your telephone
 - adjusting ring volume 80
 - Button Inquiry 73
 - changing ring type 80
 - contrast adjustment 73
- D**
- date and time
 - displayed instead of messages 81
 - displaying 30
 - length of a call 29
- defaults
 - button assignments 77
- deleting
 - Call Log items 68
 - messages from list 63
 - programmed features 75
- Denied in admin** 125
- desktop conferencing using ISDN 93
- dial pad
 - description 13
- dial tone
 - Enterprise Edge system 105
 - stuttered 105
- Dial voice call** 66
- dialing
 - automatic dial 34
 - modes 34
 - pre-dial 34
 - saved number 42
 - signal
 - Link 101
 - Long Tones 102
 - Pause 102
 - Programmed Release 102
 - run/stop 103
 - switching from pulse to tone 103
 - Wait for Dial Tone 103
 - standard dial 34
 - switching from pulse to tone 103
- Dialing Plan
 - PRI 91
- DID (Direct Inward Dial)
 - template 78
- direct inward system access (DISA) 104
- direct-dial telephone
 - programming 99
- Directed Call Pickup 119
- Directed Pickup 20
- DISA (see direct inward system access)
- disconnect
 - from conference 25
 - releasing a call, accidentally 30
 - Supervision 107
- display
 - button equivalents for one-line display 110
 - buttons 12, 13
 - Call information 19
 - changing the language 74
 - making darker or lighter 73
 - one-line 109
 - testing 122
 - time and date 30
- distinctive rings 80
- DN (see internal numbers)
- DND** 47
- DND from** 16
- DND transfer** 16
- Do Not Disturb** 87
 - canceling 87
 - on Busy 53
 - using 88
- Do not disturb** 31, 36, 46
- DRT** 16
- dual memory button 13
- E**
- Emergency 911 11
 - PRI 90
- ending a call 18
- Enter code** 75
- Enter digits** 38, 41
- Enter zone** 60
- Enterprise Edge ATA
 - Long tones 102
- Enterprise Edge features 118–120
- Enterprise Edge system dial tone 105
- Enterprise Edge telephones
 - installing 85
 - mounting on a wall 86
- erasing

Call Log items 69
 messages from list 63
 programmed features 75
 Evening Sched 98
 Exchanged 80
 Exclusive Hold 35, 44
 Expensive route 31
 external
 access to Enterprise Edge 103
 autodial programming 37
 Call Forward (see Line Redirection)
 page 59
 paging equipment 61
 extra-dial telephone 98

F

Feature

Autobumping
 canceling # 8 1 5 68
 using 8 1 5 68
 autodial button
 external * 1 37, 39
 internal * 2 37
 Background Music
 canceling # 8 6 88
 turning on 8 6 88
 Button Inquiry * 0 42, 73, 107, 121
 Call Duration Timer 7 7 29
 Call Forward
 canceling # 4 51
 using 4 51
 Call Information Feature 8 1 1 18, 19
 Call Log
 entering 8 1 2 70
 external calls 8 1 3 68
 options * 8 4 68
 password * 8 5 70
 password * 8 5 70
 viewing 8 1 2 68
 Call Park 7 4 48
 Call Pickup 7 6 21
 Call Queuing 8 0 1 44
 Call Transfer
 canceling # 7 0 46
 using 7 0 25, 45
 Camp-on 8 2 47
 Class of Service 6 8 106
 Conference Call
 M7100 telephone # 3 24, 25
 using 3 23, 24, 25
 Contrast Adjustment * 7 73
 Dialing Modes * 8 2 34
 Directed Pickup 7 6 20
 Do Not Disturb
 canceling # 8 5 87
 turning on 8 5 34, 87
 Exclusive Hold 7 9 44
 Feature Button
 programming * 3 74
 Group Listening
 canceling # 8 0 2 26
 using 8 0 2 26
 Hide message display * 8 0 6 81
 Host System Dialing Signals
 Link 7 1 101
 Long Tones 8 0 8 102
 Pause 7 8 102
 Programmed Release * 8 9 102
 Run/Stop * 9 103
 Wait for Dial Tone 8 0 4 103
 Language
 English * 5 0 1 74
 French * 5 0 2 74
 Spanish * 5 0 3 74
 Last Number Redial 5 39
 Line Pool Access 6 4 33
 Line Redirection
 canceling # 8 4 55
 using 8 4 54
 Message
 canceling # 1 62
 sending 1 61, 62, 63
 viewing ones you sent 1 64
 viewing 6 5 62
 Page
 combined zone 6 3 59
 external zone 6 2 59
 internal zone 6 1 59
 using 6 0 48, 49, 59
 Password
 Call Log * 8 5 70
 Priority Call 6 9 35
 Privacy 8 3 29
 Restriction Service
 turning off # 8 7 2 96
 turning on 8 7 2 96
 Ring Again
 canceling # 2 36
 using 2 36
 Ring Type * 6 80
 Ring Volume * 8 0 80
 Ringing Service
 turning off # 8 7 1 96
 turning on 8 7 1 96
 Routing Service
 turning off # 8 7 3 96
 turning on 8 7 3 96
 Saved Number Redial 6 7 41, 42
 Services, viewing 8 7 0 97

- Speed Dial
 - adding user *4 40
 - making calls 0 40
 - Static Time and Date 8 0 6 64
 - Testing
 - display 8 0 5 122
 - power supply 8 0 5 123
 - telephone buttons 8 0 5 122
 - telephone handset 8 0 5 122
 - telephone headset 8 0 5 123
 - telephone speaker 8 0 5 123
 - Time 7 7 30
 - Trunk Answer 8 0 0 22
 - Voice Call Deny
 - canceling # 8 8 66
 - using 8 8 66
 - Voice Call 6 6 65
 - fast busy tone 105
 - feature
 - Voice Call 120
 - wireless Call Forward No Answer 119
 - wireless Portable Language Selection 119
 - Feature button 13
 - Feature code 75
 - Feature moved 75
 - Feature timeout 125
 - features
 - adjusting ring volume 80
 - Autobumping 68
 - autodial 37
 - auxiliary ringer 101
 - Background Music 88
 - Button Inquiry 73
 - Call Display 18
 - Call Duration Timer 29
 - Call Forward 51
 - Call Information 18
 - Call Log 67
 - Call Park 48
 - Call Pickup 20
 - Call Queuing 44
 - Call Transfer 45
 - Callback 50
 - Camp-on 47
 - changing ring type 80
 - Class of Service password 106
 - Conference Calls 23
 - contrast adjustment 73
 - dialing modes 34
 - dialing signal
 - Link 101
 - Long Tones 102
 - Pause 102
 - Programmed Release 102
 - run/stop 103
 - Wait for Dial Tone 103
 - Do Not Disturb 87
 - Do Not Disturb on Busy 53
 - Exclusive Hold 44
 - Group Listening 26
 - Handsfree 26
 - hiding the message or calls display 81
 - Hold 43
 - language choice 74
 - Last Number Redial 39
 - line pools 32
 - Line Redirection 54–57
 - Messages 61
 - moving line buttons 79
 - one button access 18
 - paging 59–61
 - priority call 35
 - Privacy 29
 - Restriction service 95
 - Ring Again 36
 - ring type 80
 - Ringling service 95
 - Routing service 95
 - Saved Number Redial 41
 - sending messages using analog telephones 61
 - sending messages using display 61
 - Set Lock 100
 - Speed Dial 39
 - Test a Telephone 121–123
 - Trunk Answer 21
 - Voice Call 65
 - Voice Call Deny 66
 - file transfer using ISDN 93
 - Forward denied 54
 - Forward > 54
 - forwarding calls
 - Call Forward 51
 - Call Forward delay 52
 - Call Forward No Answer 52
 - Call Forward on Busy 52
 - Do Not Disturb on Busy 53
 - Line Redirection 54–57
- ## G
- Group 4 fax using ISDN applications 93
 - Group Listening 26
 - canceling 26
 - Group Pickup 20, 119
- ## H
- handling many calls at once
 - Call Queuing 44
 - Hold 43

- handset, speaker testing 123
- handset, testing 122
- Handsfree
 - making calls 27
 - muting 27, 28
- Handsfree Answerback
 - programming 28
 - Voice Call 65
- headset
 - Handsfree requirement 28
 - testing 123
- hearing aid compatibility 18
- Hidden number 39, 42
- Hidden number 32
- Hold
 - automatic 43
 - button 13
 - Conference Call 24
 - exclusive 44
 - getting information for a call on 19
 - listening while on hold 43
 - retrieving call 43
- Hold or release 71, 126
- Hospitality passwords 116
- Hospitality services 111
- host system signaling
 - Link 101
 - Pause 102
 - Programmed Release 102
 - run/stop 103
 - Wait for Dial Tone 103
- Hotline
 - bypassing 99
 - setting up the telephone 99
- Hunt Groups 83, 107, 118, 119
 - Broadcast mode 84
 - Distribution modes 84
 - Rotary mode 84
 - Sequential mode 84
- I**
- In use 64, 127
- In use SETNAME 71
- Inactive feature 125
- incoming call indicator 15
- Incoming only 127
- indicator
 - incoming call 15
- Integrated Services Digital Network (see ISDN)
- Intercom 56
- intercom
 - using as the line for Autodial 38
- Intercom # 38
- internal numbers
 - length of 107
- internal page 59
- Internet access using ISDN applications 94
- Invalid code 41
- Invalid code 103, 125
- Invalid location 80
- Invalid number 38
- Invalid number 46, 49, 127
- Invalid zone 60
- ISDN (Integrated Services Digital Network)
 - applications 93–94
 - description 89
 - desktop conferencing using 93
 - equipment 93–94
 - file transfer using 93
 - Group 4 fax using 93
 - Internet access using 94
 - LAN access using 93
 - LAN to LAN bridging using 94
 - leased line backup using 93
 - telecommuting using 93
 - videoconferencing and video telephony using 93
- ISDN PRI 89
 - 2-way DID 90
 - Call by Call 91
 - Dialing Plan 91
 - Emergency 911 90
 - Name and Number blocking 90
 - Network Name Display 89
- L**
- LAN
 - access using ISDN applications 93
 - router 94
 - to LAN bridging ISDN applications 94
- language, changing on the display 74
- Last Number Redial
 - programming 39
- Last Number Redial, using 39
- leased line backup using ISDN applications 93
- length of call, timing 29
- length of internal numbers 107
- limiting
 - access to Enterprise Edge 104
 - telephone feature use 100
 - telephone programming 100
 - using alternate or scheduled services 95
- line
 - assignment 107
 - button
 - moving 15, 79

- button, using to choose a line 32
- changing the name 86
- indicators, description 16
- pool 32–33, 108
- Redirection
 - canceling 55
 - using 54–57
- Redirection, and Call Forward, differences 57
- target 108
- Line 061 waiting 126
- Line denied 22, 32, 127
- Line hung up 48
- Line in use 126
- Line Pools, using 118
- Line Redirection 56
- Line061 callback 16
- Line061 hung up 46
- Line061 to Prime 16
- Line061 transfer 126
- Link
 - using 101
- Link, programming 101
- listening on hold 43
- log space
 - programming 71
- logging a call manually 68
- Logit (see Call Log)
- long distance call
 - indicator 125
 - using COS password 104
- Long Tones 102
- lost calls, troubleshooting 118
- Lunch Sched 98
- M**
- M7100 telephone
 - Autodial 37
 - button defaults 79
 - Button Inquiry 73
 - Call Conference 23
 - Call Park 48
 - Call Queuing 126
 - Call Transfer 46
 - CallBack 47, 48
 - camping a call 47
 - Conference Call 24
 - Conference Call on hold 24
 - Hold 43
 - internal numbers 107
 - line assignment 108
 - Line button 32
 - line button 15
 - line buttons 109
 - Line Redirection 54
 - memory buttons 109
 - one-line display 109
 - Ring Again 125, 126
 - Speed Dial 40
 - standard dial 34
 - Transferring a call 46
 - Voice Call 65
- M7208 telephone
 - button defaults 78
 - memory buttons 109
- M7310 telephone 12
 - button defaults 78
 - Conference Call 23
 - memory buttons 109
 - splitting a Conference Call 24
 - troubleshooting 121
- M7324 telephone 12
 - button defaults 79
 - CAP 17
 - Conference Call 23
 - memory buttons 109
 - splitting a Conference Call 24
 - troubleshooting 121
- M7410 CT 14
- maintaining security 105
- Make calls first 127
- making calls
 - dialing modes 34
 - priority call 35
 - using a line button 32
 - using line pools 32
 - using Ring Again 36
 - with automatic Handsfree 28
- memory buttons 13, 37, 109
- Message denied 64
- Message list 64
- Message to 64
- Messages
 - canceling a sent message 62
 - hiding display 81
 - removing from list 63
 - sending, using the display 61
 - viewing 62
- Messages & Calls 64, 71
- Microphone muted 66
- monitoring
 - calls 22, 108
 - with CAP 17
 - line pool status 36
 - lines (see also Disconnect Supervision) 107
 - telephone status 36

transferred calls 50
 mounting telephones on wall 110
 Move line from 80
 Move line to 80
 moving
 telephones 87
 music, background 88
 muting voice call tones 65

N

Name and Number blocking
 PRI 90
 Network Name Display
 PRI 89
 New calls begin 72
 night control phone (see control telephone)
 Night Sched 98
 Night Service (see services)
 9. 31, 127
 No button free 65, 126
 No call on 49
 No call to Park 49
 No calls waiting 126
 No free lines 127
 No info to log 72
 No last number 39
 No last number 32
 No line selected 32, 126, 127
 No line to use 56
 No log assigned 72
 No number saved 42
 No number stored 41, 65
 No resume item 72
 No services ON 97
 No voice call 66
 Not available 125
 Not in service 32, 46, 48, 54, 126

O

OK 110
 On another call 32, 36
 On hold 44
 one button access to features 18
 one button dialing (see Autodial)
 out of range 117
 Outgoing line 56
 overflow call routing 108
OVERRIDE 110
 overriding
 Call Forward 52

P

page
 external equipment 61
 programming 59
 shortcut codes 59
 types 59
 zones, programming 60
 Page choice 60
 Page timeout 60
 Paging ALL 60
 Paging busy 60
 Park denied 49
 Parked call 126
 Parked on 49
 parking a call
 retrieving 48
 Parking full 49
 password
 Call Log 70
 canceling 70
 changing 70
 Class of Service 106
 Pause 102
 pause in a sequence of numbers (see Wait for Dial
 Tone)
 PBX template 78
 Pick up receiver 126
 Pickup 21
 Pickup denied 21, 22
 pickup group 20
 Please wait 35
 Pool code 56
 portable telephone
 and Enterprise Edge 118–120
 using 117–120
 voice quality 117
 power off, effect on memory buttons 37
 power supply, testing 123
 pre-dial 34
 Press a button 38, 73, 75
 Press a line 80
 Press held line 25
 prime
 line 100
 telephone 16
 prime line 110
 priority call (see also Call Queuing) 15, 35
 Priority denied 35
 Priority>223 126
 Privacy
 changing status 29
 private

- branch exchange, accessing from Enterprise Edge (see also host system dialing signals)
 - 101
 - call 29
 - line 110
 - Program and HOLD 38, 41, 75
 - Program and OK 38, 41, 75
 - Programmed 38
 - Programmed Release 102
 - programming
 - changes, planning 11
 - features on buttons 74
 - lines
 - changing the name of a line 86
 - log space 71
 - system 11
 - system features
 - Restriction service 95
 - Ringing service 95
 - Routing service 95
 - System Speed Dial 39
 - telephones
 - allowing Line Redirection 55
 - auxiliary ringer 101
 - Call Display 20
 - Call Forward delay 52
 - Call Pickup 20
 - changing the name of a telephone 86
 - direct-dial telephones 99
 - Do Not Disturb 87
 - external autodial button 37
 - Forward no answer 52
 - Forward on busy 52
 - Handsfree 28
 - Handsfree Answerback 28
 - Hotline 99
 - page zone 60
 - paging 59
 - priority call 35
 - Redirect ring 55
 - Set lock 100
 - User Speed Dial 39, 40
 - programming telephones
 - Last Number Redial 39
 - Link 101
 - Saved Number Redial 42
- Q**
- QUIT** 110
- R**
- range 117
 - redialing
 - external number 39
 - Redirect 56
 - Redirect ring
 - programming 55
 - Redirectdenied 56
 - redirection loops, avoiding 57
 - refusing to answer second call 87
 - Release a call 48, 126
 - Release button 13, 18
 - Release calls 126
 - Release, using 119
 - releasing
 - accidentally 30
 - from conference 25
 - remote access 103–105
 - remote use
 - Class of Service password 106
 - security 104
 - using lines and features from outside the system 103
 - replying to a message 62
 - analog telephone 63, 64
 - reporting and recording alarms 121
 - Restr'n 97
 - Restricted call 32, 47, 127
 - restricting
 - access to Enterprise Edge 104
 - feature use (see Set Lock)
 - telephone feature use 100
 - telephone programming 100
 - using alternate or scheduled services 95
 - Restriction service 95
 - retrieval codes
 - Call Park 48
 - retrieving
 - held call 43
 - parked call 48
 - ring
 - auxiliary ringer 101
 - changing ring type 80
 - description of types 16, 80
 - ring volume 80
 - Ring Again 36
 - Ring Again? 32, 36
 - Ringing 97
 - Ringing service 95
 - RLS button 18
 - Room condition 114
 - Room occupancy 114
 - Routing 97
 - Routing service 95
 - run/stop signal 103

S

Saved Number Redial
 using 41

Saved Number Redial, programming 42

saving a number (see Saved Number redial)

Sched 4 98

Sched 5 98

Sched 6 98

scheduled services 95

security
 recommendations 105
 system 104

Select a line 32, 41

Select line out 56

Select line(s) 56

Send message? 32

Service Modes (see Services)

Service Modes ON 97

Service provider features
 Automatic Call Back 92
 Automatic Recall 93
 Call Forward 92
 calling the number your calls are forwarded to 92
 canceling Call Forward 92

Service Schedules
 Evening Sched 98
 Lunch Sched 98
 Night Sched 98
 Sched 4 98
 Sched 5 98
 Sched 6 98

Services
 overriding 97
 Restriction service 95
 Ringing service 95
 Routing service 95
 Trunk Answer 21
 turning off and on using feature codes 96
 viewing active schedules 96

set lock 100

Set locked 125

Set profile 109

shift button 13

SHOW 110

signal
 Link 101
 Long Tones 102
 Pause 102
 Programmed Release 102
 run/stop 103
 Wait for Dial Tone 103

softkey display prompts, troubleshooting 117

special telephones 98

Speed Dial
 host system signaling codes 39
 making a call 40
 programming for User 40

splitting a Conference Call 24

standard dial 34

Start of list 65

Still in transfer 47

stopping calls from ringing at your telephone 87

stuttered dial tone 105

suspending a call (see also Call Park and Hold)

switching between calls 119

system
 programming 11

system dial tone 105

System Speed Dial 39

T

target lines 108
 changing the name 86

telecommuting using ISDN applications 93

telephone
 alarm 121
 Call Display information 19
 CAP 17, 98
 changing the name 86
 control 96, 100
 difference between M7310 and M7324
 telephones 12
 direct-dial 98
 extra-dial 96, 98
 Hotline 99
 log calls automatically 67
 M7100, illustration 109
 mounting on wall 110
 moving 87
 prime 98
 prime telephone 16
 testing 121–123

testing
 buttons 121, 122
 display 122
 ending a session 122
 handset 122
 headset 123
 power supply 123
 telephone 121
 telephone speaker 123

Their list full 65

3 Parties only 25

time and date

displayed instead of messages and calls 81
 displaying 30
 Feature 64
 length of a call 29
 time savers
 autodial 37
 Saved Number Redial 41
 Speed Dial 39
 tone
 camped call tones 47
 controlling length 102
 remote access tones 105
 voice call 65
 tracking incoming calls
 Call Log 67
 transfer (see Call Transfer)
Transfer denied 47
 transferring calls 45
 Callback 50
 parking a call 48
 using Camp-on 47
 troubleshooting
 decrease in voice quality 117
 lost calls 118
 reporting and recording alarms 121
 softkey display prompts 117
 testing
 the headset 123
 the power supply 123
 the speaker in the handset 122
 the telephone buttons 122
 the telephone display 122
 the telephone speaker 123
 using the alarm telephone 121
 Trunk Answer 21

U

Unequipped line 56
Unknown name 71
Unknown number 41
until * 97
Use line Pool? 126
User Speed Dial 39
 using Call Forward 51
 using Do Not Disturb 88
 using your system remotely 103–105

V

videoconferencing and video using ISDN
 applications 93
VIEW 110
 viewing
 active Services 96

Call Log 68
 messages 62, 64
 Voice Call 65–66
Voice call 66
 Voice Call feature 120
 voice mail
 accessing your Enterprise Edge Voice
 Messaging system 72
 using Call Forward 53
 voice quality 117
 volume
 bar 110
 control 110

W

Wait for Dial Tone 103
 wall mounting telephones 110
 wireless Call Forward No Answer 120
 wireless Portable Language Selection 119
 English 119
 French 119
 Spanish 120

Y

Your list full 65

